

CE EMC Test Report (EN 50155 & EN 50121-3-2)

Report No.: CE181031D08-1

Test Model: ECX-1000-PoER

Series Model: ECX-1XXXXXXXXXXXXXXXXX
("X" can be 0-9,A-Z or blank for marketing purpose)

Received Date: Oct. 31, 2018

Test Date: Nov. 12 ~ 23, 2018

Issued Date: Nov. 27, 2018

Applicant: Vecow Co., Ltd.

Address: 12F., No. 111, Zhongcheng Rd., Tucheng Dist., New Taipei City 23674
Taiwan (R.O.C.)

Issued By: Bureau Veritas Consumer Products Services (H.K.) Ltd., Taoyuan Branch

Lab Address: No. 47-2, 14th Ling, Chia Pau Vil., Lin Kou Dist., New Taipei City, Taiwan
(R.O.C.)



This report is for your exclusive use. Any copying or replication of this report to or for any other person or entity, or use of our name or trademark, is permitted only with our prior written permission. This report sets forth our findings solely with respect to the test samples identified herein. The results set forth in this report are not indicative or representative of the quality or characteristics of the lot from which a test sample was taken or any similar or identical product unless specifically and expressly noted. Our report includes all of the tests requested by you and the results thereof based upon the information that you provided to us. You have 60 days from date of issuance of this report to notify us of any material error or omission caused by our negligence, provided, however, that such notice shall be in writing and shall specifically address the issue you wish to raise. A failure to raise such issue within the prescribed time shall constitute your unqualified acceptance of the completeness of this report, the tests conducted and the correctness of the report contents. Unless specific mention, the uncertainty of measurement has been explicitly taken into account to declare the compliance or non-compliance to the specification. The report must not be used by the client to claim product certification, approval, or endorsement by TAF or any government agencies.

Table of Contents

Release Control Record	4
1 Certificate of Conformity	5
2 Summary of Test Results	6
2.1 Performance Criteria	8
2.2 Measurement Uncertainty	8
2.3 Modification Record.....	8
3 General Information	9
3.1 Description of EUT	9
3.2 Features of EUT	9
3.3 Operating Modes of EUT and Determination of Worst Case Operating Mode	10
3.4 Test Program Used and Operation Descriptions.....	11
3.5 Primary Clock Frequencies of Internal Source.....	11
4 Configuration and Connections with EUT	12
4.1 Connection Diagram of EUT and Peripheral Devices	12
4.2 Configuration of Peripheral Devices and Cable Connections	14
5 Conducted Disturbance at Auxiliary a.c. or d.c. Power Ports	16
5.1 Limits	16
5.2 Test Instruments	16
5.3 Test Arrangement	17
5.4 Test Results	18
6 Radiated Disturbance up to 1 GHz	20
6.1 Limits	20
6.2 Test Instruments	20
6.3 Test Arrangement	21
6.4 Test Results	22
7 Radiated Disturbance above 1 GHz	24
7.1 Limits	24
7.2 Test Instruments	25
7.3 Test Arrangement	26
7.4 Test Results	27
8 Electrostatic Discharge Immunity Test (ESD)	29
8.1 Test Specification.....	29
8.2 Test Instruments	29
8.3 Test Arrangement	30
8.4 Test Results	31
9 Radio-frequency Electromagnetic Field Immunity Test (RS)	35
9.1 Test Specification.....	35
9.2 Test Instruments	35
9.3 Test Arrangement	36
9.4 Test Results	37
10 Electrical Fast Transient/Burst Immunity Test (EFT)	38
10.1 Test Specification.....	38
10.2 Test Instruments	38
10.3 Test Arrangement	39
10.4 Test Results	40

11	Surge Immunity Test.....	41
11.1	Test Specification.....	41
11.2	Test Instruments	41
11.3	Test Arrangement	42
11.4	Test Results	42
12	Immunity to Conducted Disturbances Induced by RF Fields (CS).....	43
12.1	Test Specification.....	43
12.2	Test Instruments	43
12.3	Test Arrangement	44
12.4	Test Results	45
13	Pictures of Test Arrangements	46
13.1	Conducted Disturbance at Auxiliary a.c. or d.c. power ports	46
13.2	Radiated Disturbance up to 1 GHz	47
13.3	Radiated Disturbance above 1 GHz.....	48
13.4	Electrostatic Discharge Immunity Test (ESD)	49
13.5	Radio-frequency Electromagnetic Field Immunity Test (RS)	50
13.6	Fast Transients (EFT).....	51
13.7	Surge	52
13.8	Radio-frequency common mode (CS).....	53
Appendix – Information on the Testing Laboratories		55

Release Control Record

Issue No.	Description	Date Issued
CE181031D08-1	Original release.	Nov. 27, 2018

2 Summary of Test Results

EN 50121-3-2:2016, Emission EN 50155:2007 +AC:2010 +AC:2012, Clause 12.2.8.2			
Port	Test Item / specifications	Result/Remarks	Verdict
Auxiliary a.c. or d.c. power ports - Auxiliary supply sinusoidal a.c. or d.c.	Conducted disturbance 150 kHz- 500 kHz: 99 dB μ V quasi-peak 500 kHz- 30 MHz: 93 dB μ V quasi-peak	Minimum passing margin is -50.89 dB at 1.63281 MHz	Pass
Auxiliary a.c. or d.c. power ports – AC power outlet port for public use	Conducted disturbance 50 Hz- 2 kHz: THD <8% (THD: total harmonic distortion)	Test not applicable because the port does not exist.	N/A
Battery referenced ports - Battery power supply	Conducted disturbance 150 kHz- 500 kHz: 99 dB μ V quasi-peak 500 kHz- 30 MHz: 93 dB μ V quasi-peak	Test not applicable because the port does not exist.	N/A
Enclosure	Radiated disturbance 30 MHz- 230 MHz: 40 dB μ V/m quasi-peak 230 MHz -1 GHz: 47 dB μ V/m quasi-peak	Minimum passing margin is -1.00 dB at 154.00 MHz	Pass
Enclosure	Radiated disturbance 1 GHz- 3 GHz: 76 dB μ V/m peak 56 dB μ V/m average 3 GHz - 6 GHz: 80 dB μ V/m peak 60 dB μ V/m average	Minimum passing margin is -5.99 dB at 2774.77 MHz	Pass

EN 50121-3-2:2016, Immunity requirements, EN 50155:2007 +AC:2010 +AC:2012, Clause 12.2.7 & 12.2.8.1					
Table Clause	Basic standard	Port	Test Item / specifications	Result/Remarks	Verdict
3.1	EN 61000-4-6:2014	Battery referenced ports (except at the output of energy sources), Auxiliary a.c. power input ports (rated voltage \leq 400 Vrms)	Radio-frequency common mode (CS) 80% AM (1kHz) 0.15-80 MHz, 10V Performance Criterion A	Performance Criterion A	Pass
3.2	EN 61000-4-4:2012	Battery referenced ports (except at the output of energy sources), Auxiliary a.c. power input ports (rated voltage \leq 400 Vrms)	Fast Transients (EFT) 5/50 (T _r /T _h) ns, 5kHz \pm 2kV Performance Criterion A	Performance Criterion A	Pass
3.3	EN 61000-4-5:2014	Battery referenced ports (except at the output of energy sources), Auxiliary a.c. power input ports (rated voltage \leq 400 Vrms)	Surges 1.2/50 (8/20) (T _r /T _h) μ s Line to ground: \pm 2kV 42 Ω , 0.5 μ F Line to line: \pm 1kV 42 Ω , 0.5 μ F Performance Criterion B	Performance Criterion A	Pass

EN 50121-3-2:2016, Immunity requirements,
 EN 50155:2007 +AC:2010 +AC:2012, Clause 12.2.7 & 12.2.8.1

Table Clause	Basic standard	Port	Test Item / specifications	Result/Remarks	Verdict
4.1	EN 61000-4-6:2014	Signal & communication, process measurement & control ports	Radio-frequency common mode (CS) 80% AM (1kHz) 0.15-80 MHz, 10V Performance Criterion A	Performance Criterion A	Pass
4.2	EN 61000-4-4:2012	Signal & communication, process measurement & control ports	Fast Transients (EFT) 5/50 (T _r /T _h) ns, 5kHz ±2kV, Capacitive clamp Performance Criterion A	Performance Criterion A	Pass
5.1	EN 61000-4-3:2006 +A1:2008 +A2:2010	Enclosure ports	Radio-frequency electromagnetic field amplitude modulated (RS) ¹ , 80% AM (1kHz) 80-800 MHz, 20V/m Performance Criterion A	Performance Criterion A	Pass
5.2	EN 61000-4-3:2006 +A1:2008 +A2:2010	Enclosure ports	Radio-frequency electromagnetic field from digital mobile telephones (RS) ² , 80% AM (1kHz) 800-1000 MHz, 20V/m 1400-2000 MHz, 10V/m 2000-2700 MHz, 5V/m 5100-600 MHz, 3V/m Performance Criterion A	Performance Criterion A	Pass
5.3	EN 61000-4-2:2009	Enclosure ports	Electrostatic Discharges (ESD) ±6kV Contact discharge ±8kV Air discharge Performance Criterion B	Performance Criterion A	Pass

Note 1: This limit applies to equipment mounted in the passenger compartments, drivers cab or external to the rolling stock (roof, underframe). For equipment mounted in all other areas a severity level of 10 V/m may be used.

Note 2: For large apparatus (e.g. traction drives, auxiliary converters) it is often not practical to perform the immunity test to radiated electromagnetic fields on the complete unit. In such cases the manufacturer should test susceptible sub-systems (e.g. control electronics). The test report should justify the selection or not of sub-systems and any assumptions made (e.g. reduction of field due to case shielding).

Note:

1. There is no deviation to the applied test methods and requirements covered by the scope of this report.
2. The above EN basic standards are applied with latest version if customer has no special requirement.
3. N/A: Not Applicable

2.1 Performance Criteria

General Performance Criteria

The general performance criteria apply for those ports for which no specific performance criteria are defined (e.g. auxiliary ports) in the report.

Performance criterion A: The apparatus shall continue to operate as intended during and after the test. No degradation of performance or loss of function is allowed below a performance level specified by the manufacturer, when the apparatus is used as intended. The performance level may be replaced by a permissible loss of performance. If the minimum performance level or the permissible performance loss is not specified by the manufacturer, either of these may be derived from the product description and documentation, and from what the user may reasonably expect from the apparatus if used as intended..

Performance criterion B: The apparatus shall continue to operate as intended after the test. No degradation of performance or loss of function is allowed below a performance level specified by the manufacturer, when the apparatus is used as intended. The performance level may be replaced by a permissible loss of performance. During the test, degradation of performance is however allowed. No change of actual operating state or stored data is allowed. If the minimum performance level or the permissible performance loss is not specified by the manufacturer, either of these may be derived from the product description and documentation, and from what the user may reasonably expect from the apparatus if used as intended.

Performance criterion C: Temporary loss of function is allowed, provided the function is selfrecoverable or can be restored by the operation of the controls.

2.2 Measurement Uncertainty

Where relevant, the following measurement uncertainty levels have been estimated for tests performed on the EUT as specified in CISPR 16-4-2:

The listed uncertainties are the worst case uncertainty for the entire range of measurement. Please note that the uncertainty values are provided for informational purposes only and are not used in determining the PASS/FAIL results.

Measurement	Expanded Uncertainty (k=2) (\pm)	Maximum allowable uncertainty (\pm)
Conducted disturbance at mains port using AMN, 150kHz ~ 30MHz	2.77 dB	3.4 dB (U_{CISPR})
Radiated disturbance, 30MHz ~ 1GHz	3.97 dB	6.3 dB (U_{CISPR})
Radiated disturbance, 1GHz ~ 6GHz	5.08 dB	5.2 dB (U_{CISPR})

The other instruments specified are routine verified to remain within the calibrated levels, no measurement uncertainty is required to be calculated.

2.3 Modification Record

There were no modifications required for compliance.

3 General Information

3.1 Description of EUT

Product	High-Performance Fanless System
Brand	Vecow
Test Model	ECX-1000-PoER
Series Model	ECX-1XXXXXXXXXXXXXXXXX (“X” can be 0-9,A-Z or blank for marketing purpose)
Model Difference	Marketing Differentiation
Sample Status	Engineering sample
Operating Software	Windows 10
Power Supply Rating	24V, DC-in
Accessory Device	Adapter
Data Cable Supplied	N/A

Note:

1. The EUT is a High-Performance Fanless System with following interfaces:

- ✧ COM*4
- ✧ USB 3.0*6
- ✧ Isolated DIO
- ✧ DVI-D (resolution up to 1920 x 1200 @ 60Hz)
- ✧ DVI-I (resolution up to 1920 x 1200 @ 60Hz)
- ✧ DP (resolution up to 4096 x 2304 @ 60Hz)
- ✧ Line out
- ✧ Mic. in
- ✧ LAN (10/100/1000Mbps)*2
- ✧ POE LAN*4
- ✧ DC input

2. The EUT uses following adapter.

Brand	FSP
Model	FSP120-AABN2
Input Power	100-240Vac, 50-60Hz, 1.8A
Output Power	24V, 5A
Power Line	Non-shielded DC (1.5m) with one ferrite core Non-shielded AC (1.8m)

3.2 Features of EUT

1. The tests reported herein were performed according to the method specified by Vecow Co., Ltd., for detailed feature description, please refer to the manufacturer's specifications or user's manual.

2. The EUT was configured with the following key components:

Component	Brand	Model No. or P/N	Spec.
CPU	Intel	i7-8700	3.20 GHz
Memory	Kingston	KVR21S15S8/4	4GB
CFast	innodisk	3ME3 Series	64GB

3.3 Operating Modes of EUT and Determination of Worst Case Operating Mode

1. The EUT is designed with AC power of rating 100-240Vac, 50/60Hz.
For radiated emission evaluation, 230Vac/50Hz & 110Vac/60Hz (for EN 55032), 230Vac/50Hz (for EN 55011), 120Vac/60Hz (for FCC Part 15) had been covered during the pre-test. The worst data was found at **230Vac/50Hz** and recorded in the applied test report.
2. Test modes are presented in the report as below.

Mode	Test Condition	Input Power
Conducted emission test		
1	Full system	230Vac/ 50Hz
Radiated emission test		
1	Full system	230Vac/ 50Hz
Harmonics, Flicker, Immunity tests		
1	Full system	230Vac/ 50Hz

3.4 Test Program Used and Operation Descriptions

Emission tests:

- a. Turned on the power of all equipment.
- b. EUT ran a test program to enable all functions.
- c. EUT read and wrote messages from/to SSD and ext. HDDs.
- d. EUT sent and received messages to/from Notebook PCs (kept in a remote area) via two UTP LAN cables.
- e. EUT sent "H" messages to ext. LCD Monitors. Then they displayed "H" patterns on their screens simultaneously.
- f. EUT sent 1kHz audio signal to earphone.
- g. EUT sent messages to printer and printer printed them out.
- h. Cameras captured video image to LCD Monitors via EUT.
- i. Steps c-h were repeated.

Immunity tests:

- a. Turned on the power of all equipment.
- b. EUT ran a test program to enable all functions.
- c. EUT read and wrote messages from/to SSD and ext. USB flashes.
- d. EUT sent and received messages to/from Notebook PCs (kept in a remote area) via two UTP LAN cables.
- e. EUT sent and received messages to/from Notebook PCs (kept in a remote area) via two STP LAN cables. **(For CS test only)**
- f. EUT sent "H" messages to ext. LCD Monitors. Then they displayed "H" patterns on their screens simultaneously.
- g. EUT sent audio signal to speaker.
- h. Cameras captured video image to LCD Monitors via EUT.
- i. Steps c-h were repeated.

3.5 Primary Clock Frequencies of Internal Source

The highest frequency generated or used within the EUT or on which the EUT operates or tunes is 3200 MHz, provided by Vecow Co., Ltd., for detailed internal source, please refer to the manufacturer's specifications.

4 Configuration and Connections with EUT

4.1 Connection Diagram of EUT and Peripheral Devices

Emission tests:

TEST CONFIGURATION

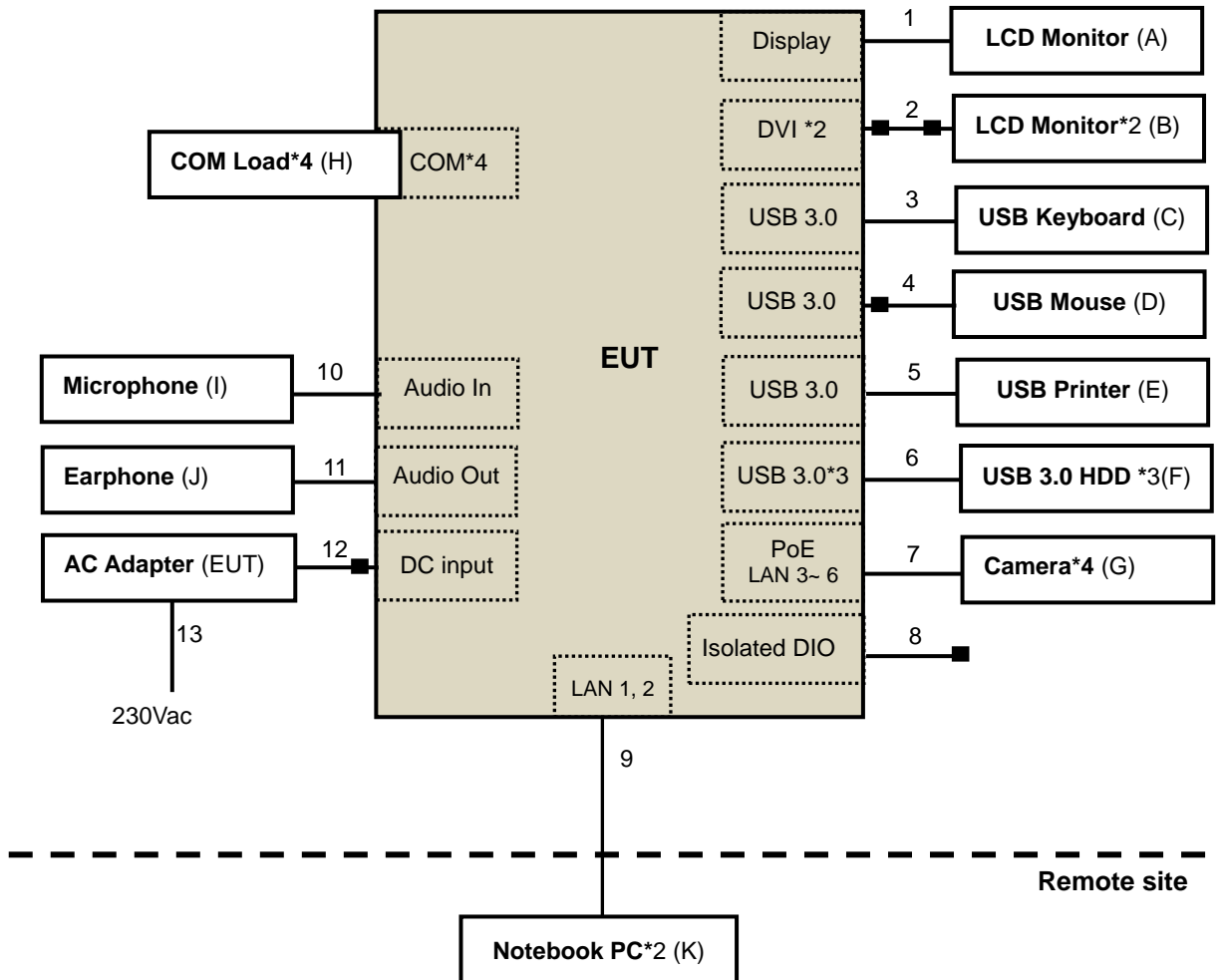

Immunity tests:

TEST CONFIGURATION

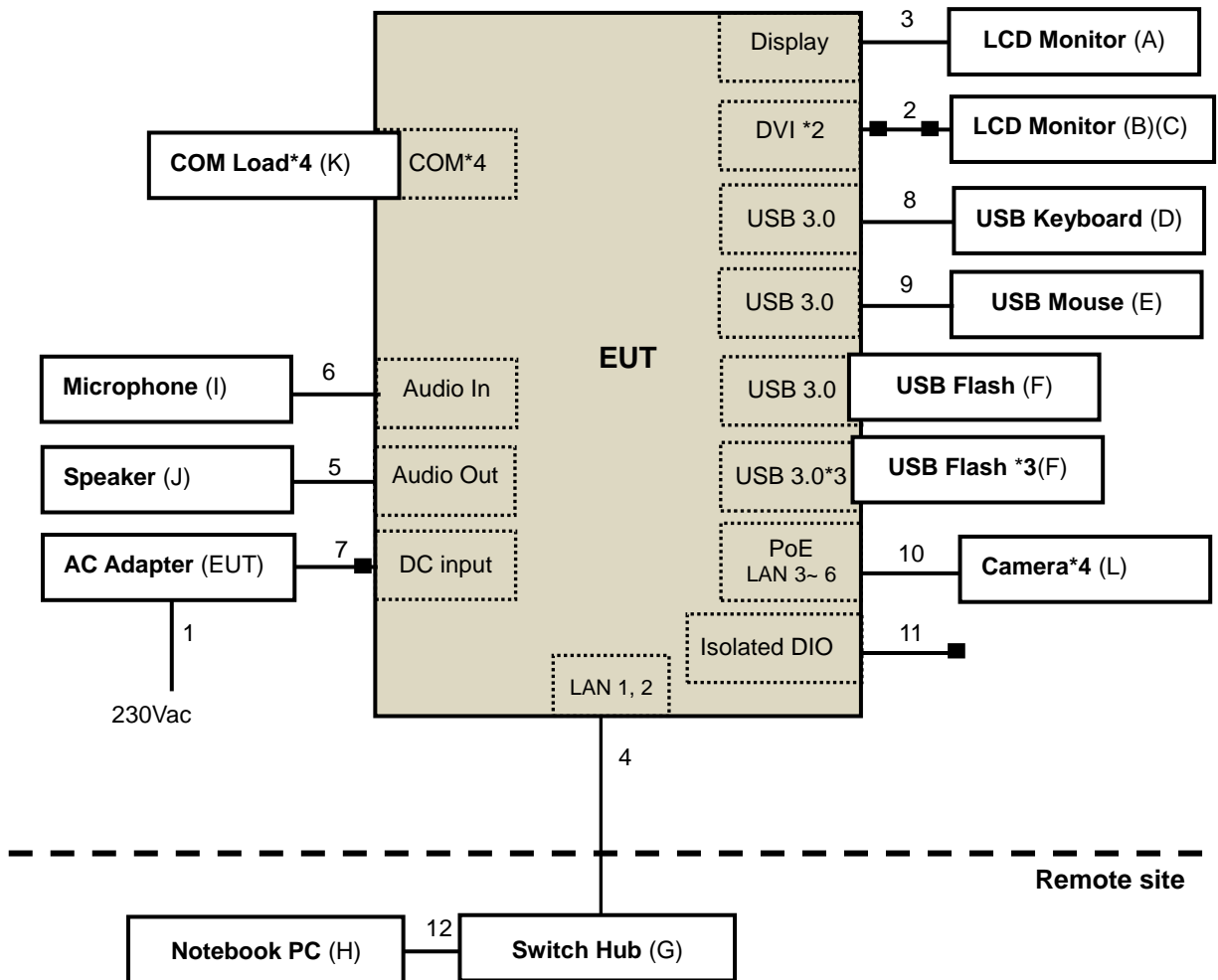

4.2 Configuration of Peripheral Devices and Cable Connections

Emission tests:

ID	Product	Brand	Model No.	Serial No.	FCC ID	Remarks
A.	LCD Monitor	ASUS	MG28UQ	N/A	FCC DoC Approved	Provided by Lab
B.	24" LCD MONITOR	DELL	U2410	CN082WXD728720CC 0UHL	FCC DoC Approved	Provided by Lab
	24" LCD MONITOR	DELL	U2410	CN082WXD728720CC 0LGL	FCC DoC Approved	Provided by Lab
C.	USB KEYBOARD	Dell	KB216t	CN-0W33XP-LO300-7 CL-190A	FCC DoC Approved	Provided by Lab
D.	USB Mouse	Microsoft	1113	9170515772204	FCC DoC Approved	Provided by Lab
E.	Printer	HP	Officejet pro 251dw	N/A	B94SDGOB1191	Provided by Lab
F.	USB 3.0 Hard Disk	WD	WDBUZG0010BB K-PESN	WXM1E1532Z4Z	FCC DoC Approved	Provided by Lab
	USB 3.0 Hard Disk	WD	WDBUZG0010BB K-PESN	WX61A45JRXLf	FCC DoC Approved	Provided by Lab
	USB 3.0 Hard Disk	WD	WDBUZG0010BB K-PESN	WX61A45JR2YK	FCC DoC Approved	Provided by Lab
G.	IP Camera*4	N/A	A301RZ-0309P	N/A	N/A	Provided by Lab
H.	COM Load*4	N/A	N/A	N/A	N/A	Provided by Lab
I.	MICROPHONE	Labtec	mic-333	N/A	N/A	Provided by Lab
J.	EARPHONE	PHILIPS	SBC HL145	N/A	N/A	Provided by Lab
K.	Notebook PC	SONY	SVS151A12P	275548477001024	FCC DoC Approved	Provided by Lab
	Notebook PC	ASUS	PU401L	ECNXC012528528	FCC DoC Approved	Provided by Lab

Note:

1. All power cords of the above support units are non-shielded (1.8m).
2. Item K acted as communication partners to transfer data.

ID	Descriptions	Qty.	Length (m)	Shielding (Yes/No)	Cores (Qty.)	Remarks
1.	Display cable	1	1.8	Y	0	Provided by Lab
2.	DVI cable	2	1.8	Y	2	Provided by Lab
3.	USB cable	1	1.8	Y	0	Provided by Lab
4.	USB cable	1	1.8	Y	1	Provided by Lab
5.	USB cable	1	1.5	Y	0	Provided by Lab
6.	USB cable	3	0.4	Y	0	Provided by Lab
7.	LAN cable	4	1.5	Y	0	Supplied by client
8.	Signal cable	1	0.3	N	0	Provided by Lab
9.	LAN cable	2	10	Y	0	Provided by Lab
10.	Audio cable	1	1.5	N	0	Provided by Lab
11.	Audio cable	1	2.0	N	0	Provided by Lab
12.	DC power	1	1.5	N	1	Supplied by client
13.	AC power cord	1	1.8	N	0	Supplied by client

Note: The core(s) is(are) originally attached to the cable(s).

Immunity tests:

ID	Product	Brand	Model No.	Serial No.	FCC ID	Remarks
A.	LCD MONITOR	DELL	2408WFP	CN0G293H74261874260S	FCC DoC Approved	Provided by Lab
B.	LCD MONITOR	DELL	U2410	CN082WXD728720CC0KDL	FCC DoC Approved	Provided by Lab
C.	LCD MONITOR	DELL	2408WFP	CN0NN79274261823S1DMS	FCC DoC Approved	Provided by Lab
D.	USB KEYBOARD	HP	SK-2085	N/A	N/A	Provided by Lab
E.	USB Mouse	ASUS	MOBTUO	N/A	N/A	Provided by Lab
F.	USB 3.0 Flash*4	ADATA	16G	N/A	N/A	Provided by Lab
G.	Switch Hub	ASUS	GP-105	N/A	N/A	Provided by Lab
H.	Notebook PC	Lenovo	T470	PF-0QW0NQ	FCC DoC Approved	Provided by Lab
I.	Microphone	N/A	N/A	N/A	N/A	Provided by Lab
J.	Speaker	N/A	N/A	N/A	N/A	Provided by Lab
K.	COM Load*4	N/A	N/A	N/A	N/A	Provided by Lab
L.	IP Camera*4	N/A	A301RZ-0309P	N/A	N/A	Provided by Lab

Note:

1. All power cords of the above support units are non-shielded (1.8m).
2. Items G-H acted as communication partners to transfer data.

ID	Descriptions	Qty.	Length (m)	Shielding (Yes/No)	Cores (Qty.)	Remarks
1.	AC power cord	1	1.8	N	0	Supplied by client
2.	DVI cable	2	1.8	Y	2	Provided by Lab
3.	Display cable	1	1.8	Y	0	Provided by Lab
4.	LAN cable	2	10	N	0	Provided by Lab
	LAN cable (For CS test only)	2	10	Y	0	Provided by Lab
5.	Audio cable	1	0.6	N	0	Provided by Lab
6.	Audio cable	1	0.6	N	0	Provided by Lab
7.	DC power	1	1.5	N	1	Supplied by client
8.	USB cable	1	1.8	Y	0	Provided by Lab
9.	USB cable	1	1.8	Y	0	Provided by Lab
10.	LAN cable	4	3	Y	0	Supplied by client
11.	Signal cable	1	0.3	N	0	Provided by Lab
12.	LAN cable	1	10	N	0	Provided by Lab

Note: The core(s) is(are) originally attached to the cable(s).

5 Conducted Disturbance at Auxiliary a.c. or d.c. Power Ports

5.1 Limits

Frequency (MHz)	Quasi-peak, (dBuV)
0.15 - 0.5	99
0.5 - 30	93

- Notes: 1. The lower limit shall apply at the transition frequencies.
 2. The limit decreases linearly with the logarithm of the frequency in the range of 0.15 to 0.50 MHz.

5.2 Test Instruments

Description & Manufacturer	Model No.	Serial No.	Cal. Date	Cal. Due
ROHDE & SCHWARZ TEST RECEIVER	ESCS 30	838251/021	Nov. 1, 2018	Oct. 31, 2019
ROHDE & SCHWARZ Artificial Mains Network (For EUT)	ENV216	101195	May 2, 2018	May 1, 2019
LISN With Adapter (for EUT)	AD10	C03Ada-002	May 2, 2018	May 1, 2019
EMCO L.I.S.N. (For peripherals)	3825/2	9504-2359	Jul. 26, 2018	Jul. 25, 2019
SCHWARZBECK Artificial Mains Network (For EUT)	NNLK8129	8129229	May 3, 2018	May 2, 2019
SCHWARZBECK Artificial Mains Network (For EUT)	NNLK 8121	8121-808	Mar. 5, 2018	Mar. 4, 2019
Software	Cond_V7.3.7.4	NA	NA	NA
RF cable (JYEBAO) With 10dB PAD	5D-FB	Cable-C03-01	Sep. 18, 2018	Sep. 17, 2019
LYNICS Terminator (For EMCO LISN)	0900510	E1-01-300	Jan. 19, 2018	Jan. 18, 2019
LYNICS Terminator (For EMCO LISN)	0900510	E1-01-301	Jan. 19, 2018	Jan. 18, 2019
ROHDE & SCHWARZ Artificial Mains Network (For TV EUT)	ESH3-Z5	100220	Nov. 14, 2017	Nov. 13, 2018
LISN With Adapter (for TV EUT)	100220	N/A	Nov. 14, 2017	Nov. 13, 2018

- Notes: 1. The calibration interval of the above test instruments is 12 months and the calibrations are traceable to NML/ROC and NIST/USA.
 2. The test was performed in Shielded Room No. 3.
 3. The VCCI Site Registration No. C-10274.
 4. Tested Date: Nov. 12, 2018

5.3 Test Arrangement

- The EUT was placed 0.4 meters from the conducting wall of the shielded room with EUT being connected to the power mains through a line impedance stabilization network (LISN). Other support units were connected to the power mains through another LISN. The two LISNs provide 50 Ohm/ 50uH of coupling impedance for the measuring instrument.
- Both lines of the power mains connected to the EUT were checked for maximum conducted interference.
- The test results of conducted emissions at mains ports are recorded of six worst margins for quasi-peak (mandatory) [and average (if necessary)] values against the limits at frequencies of interest unless the margin is 20 dB or greater.

Note: The resolution bandwidth and video bandwidth of test receiver is 9kHz for quasi-peak detection (QP) and average detection (AV) at frequency 0.15MHz-30MHz.

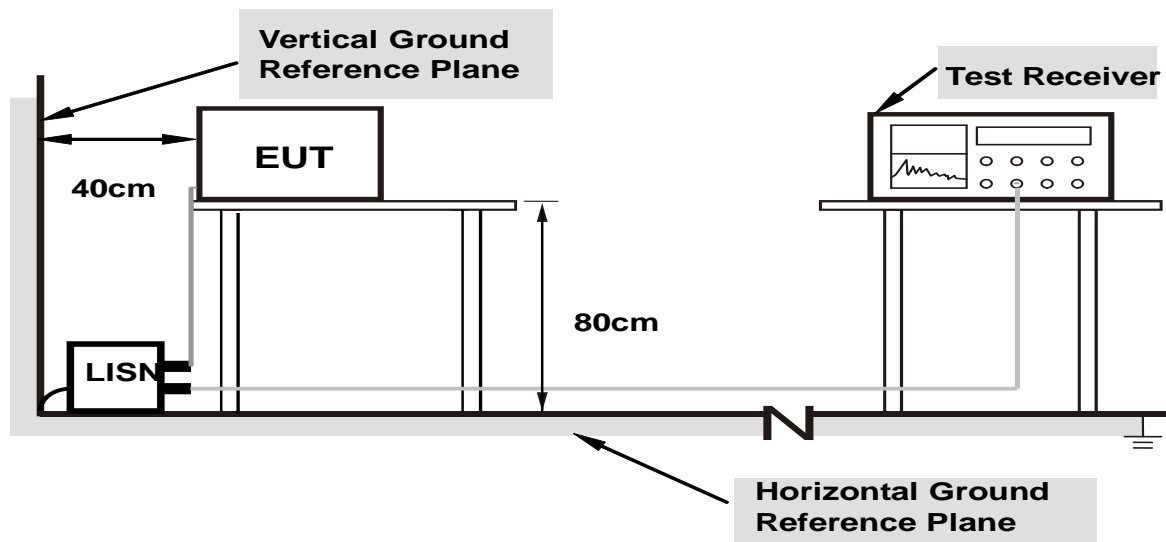

Note: Support units were connected to second LISN.

For the actual test configuration, please refer to the related item – Photographs of the Test Configuration.

5.4 Test Results

Frequency Range	150kHz ~ 30MHz	Detector Function & Bandwidth	Quasi-Peak (QP), 9kHz
Input Power	230Vac, 50Hz	Environmental Conditions	23°C, 70%RH
Tested by	Vic Lin		
Test Mode	Mode 1		

Phase Of Power : Line (L)						
No	Frequency (MHz)	Correction Factor (dB)	Reading Value (dBuV)	Emission Level (dBuV)	Limit (dBuV)	Margin (dB)
			Q.P.	Q.P.	Q.P.	Q.P.
1	0.16172	9.68	36.50	46.18	99.00	-52.82
2	0.47813	9.70	36.09	45.79	99.00	-53.21
3	0.72422	9.71	31.16	40.87	93.00	-52.13
4	1.19922	9.74	30.54	40.28	93.00	-52.72
5	14.50781	9.95	26.27	36.22	93.00	-56.78
6	23.58984	9.99	28.47	38.46	93.00	-54.54

Remarks:

1. Q.P. and AV. are abbreviations of quasi-peak and average individually.
2. The emission levels of other frequencies were very low against the limit.
3. Margin value = Emission level – Limit value
4. Correction factor = Insertion loss + Cable loss
5. Emission Level = Correction Factor + Reading Value

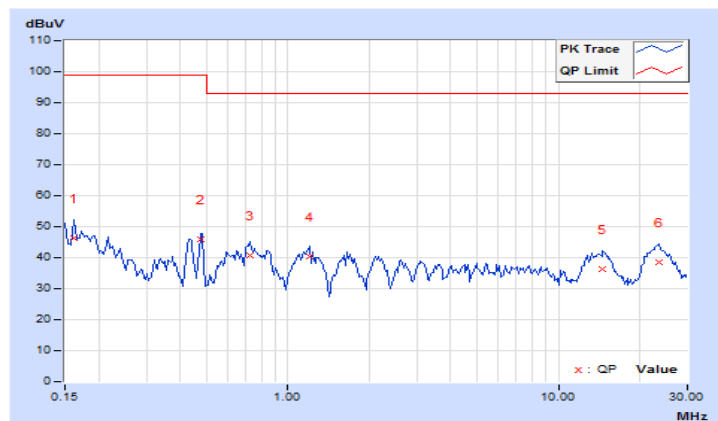

Frequency Range	150kHz ~ 30MHz	Detector Function & Bandwidth	Quasi-Peak (QP), 9kHz
Input Power	230Vac, 50Hz	Environmental Conditions	23°C, 70%RH
Tested by	Vic Lin		
Test Mode	Mode 1		

Phase Of Power : Neutral (N)						
No	Frequency (MHz)	Correction Factor (dB)	Reading Value (dBuV)	Emission Level (dBuV)	Limit (dBuV)	Margin (dB)
			Q.P.	Q.P.	Q.P.	Q.P.
1	0.15000	9.68	36.09	45.77	99.00	-53.23
2	0.16562	9.68	32.89	42.57	99.00	-56.43
3	0.47813	9.70	37.32	47.02	99.00	-51.98
4	1.21094	9.74	31.44	41.18	93.00	-51.82
5	1.63281	9.76	32.35	42.11	93.00	-50.89
6	23.07813	10.05	28.50	38.55	93.00	-54.45

Remarks:

1. Q.P. and AV. are abbreviations of quasi-peak and average individually.
2. The emission levels of other frequencies were very low against the limit.
3. Margin value = Emission level – Limit value
4. Correction factor = Insertion loss + Cable loss
5. Emission Level = Correction Factor + Reading Value

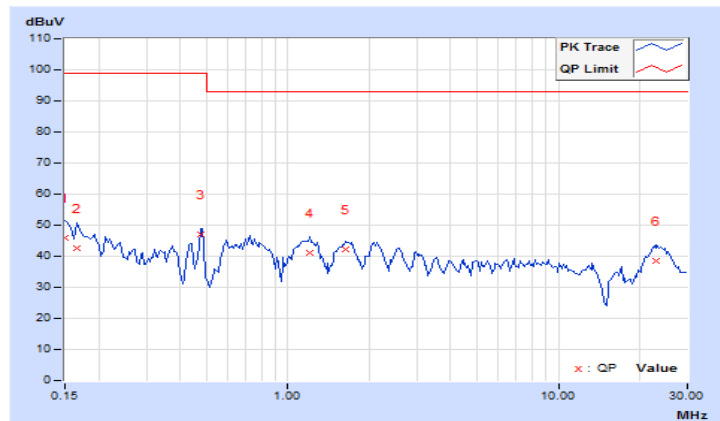

6 Radiated Disturbance up to 1 GHz

6.1 Limits

Frequency (MHz)	dBuV/m (at 10m) / quasi-peak
30 - 230	40
230 - 1000	47

- Notes:
1. The lower limit shall apply at the transition frequencies.
 2. Emission level (dBuV/m) = 20 log Emission level (uV/m).
 3. All emanations from a class A/B digital device or system, including any network of conductors and apparatus connected thereto, shall not exceed the level of field strengths specified above.

6.2 Test Instruments

Description & Manufacturer	Model No.	Serial No.	Cal. Date	Cal. Due
ROHDE & SCHWARZ TEST RECEIVER	ESCS 30	100027	Dec. 4, 2017	Dec. 3, 2018
Schwarzbeck Bilog Antenna	VULB9168	9168-303	Nov. 29, 2017	Nov. 28, 2018
Agilent Preamplifier	8447D	2944A08119	Feb. 21, 2018	Feb. 20, 2019
ADT. Turn Table	TT100	0205	NA	NA
ADT. Tower	AT100	0205	NA	NA
Software	Radiated_V7.6.15.9.5	NA	NA	NA
ADT RF Switches BOX	EMH-011	1001	Oct. 25, 2018	Oct. 24, 2019
Pacific RF cable With 5dB PAD	8D	CABLE-ST2-01	Oct. 25, 2018	Oct. 24, 2019

- Notes:
1. The calibration interval of the above test instruments is 12 months and the calibrations are traceable to NML/ROC and NIST/USA.
 2. The test was performed in Open Site No. 2.
 3. The VCCI Site Registration No. R-237.
 4. Tested Date: Nov. 13, 2018

6.3 Test Arrangement

- The EUT was placed on the top of a rotating table 0.8 meters above the ground at an accredited test facility. The table was rotated 360 degrees to determine the position of the highest radiation.
- The EUT was set 10 meters away from the interference-receiving antenna, which was mounted on the top of a variable-height antenna tower.
- The antenna is a broadband antenna, and its height is varied from one meter to four meters above the ground to determine the maximum value of the field strength. Both horizontal and vertical polarizations of the antenna are set to make the measurement.
- For each suspected emission, the EUT was arranged to its worst case and then the antenna was tuned to heights from 1 meter to 4 meters and the rotatable table was turned from 0 degrees to 360 degrees to find the maximum reading.
- The test-receiver system was set to quasi-peak detect function and specified bandwidth with maximum hold mode when the test frequency is up to 1 GHz.

Note: The resolution bandwidth and video bandwidth of test receiver/spectrum analyzer is 120kHz for quasi-peak detection (QP) at frequency up to 1GHz.

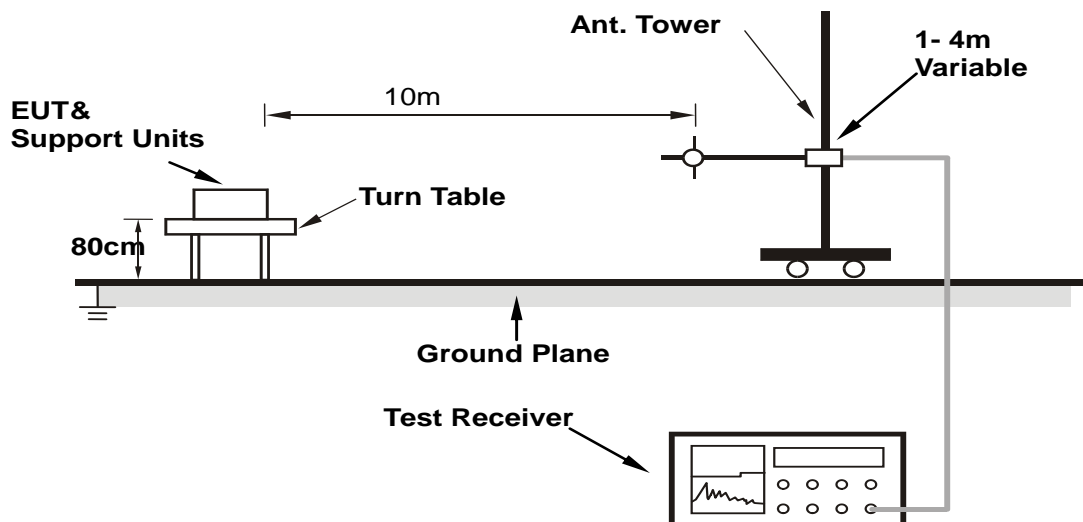

For the actual test configuration, please refer to the related item – Photographs of the Test Configuration.

6.4 Test Results

Frequency Range	30MHz ~ 1GHz	Detector Function & Bandwidth	Quasi-Peak (QP), 120kHz
Tested by	ED. Lin	Environmental Conditions	23°C, 70%RH
Test Mode	Mode 1		

Antenna Polarity & Test Distance : Horizontal at 10 m								
No	Frequency (MHz)	Emission Level (dBuV/m)	Limit (dBuV/m)	Margin (dB)	Antenna Height (m)	Table Angle (Degree)	Raw Value (dBuV)	Correction Factor (dB/m)
1	63.20	32.86 QP	40.00	-7.14	3.99 H	108	42.74	-9.88
2	116.30	33.78 QP	40.00	-6.22	3.99 H	244	45.18	-11.40
3	154.01	38.96 QP	40.00	-1.04	4.00 H	214	47.76	-8.80
4	307.87	40.16 QP	47.00	-6.84	3.23 H	298	48.39	-8.23
5	375.25	41.27 QP	47.00	-5.73	1.91 H	23	47.71	-6.44
6	425.50	39.27 QP	47.00	-7.73	2.37 H	266	44.36	-5.09
7	462.25	43.07 QP	47.00	-3.93	1.72 H	21	47.39	-4.32
8	701.50	38.25 QP	47.00	-8.75	1.26 H	109	37.76	0.49
9	838.75	39.31 QP	47.00	-7.69	1.22 H	294	36.91	2.40
10	924.00	45.01 QP	47.00	-1.99	1.02 H	262	41.08	3.93

Remarks:

1. Emission Level(dBuV/m) = Raw Value(dBuV) + Correction Factor(dB/m)
2. Correction Factor(dB/m) = Antenna Factor (dB/m) + Cable Factor (dB) – Pre-Amplifier Factor (dB)
3. The other emission levels were very low against the limit.
4. Margin value = Emission level – Limit value

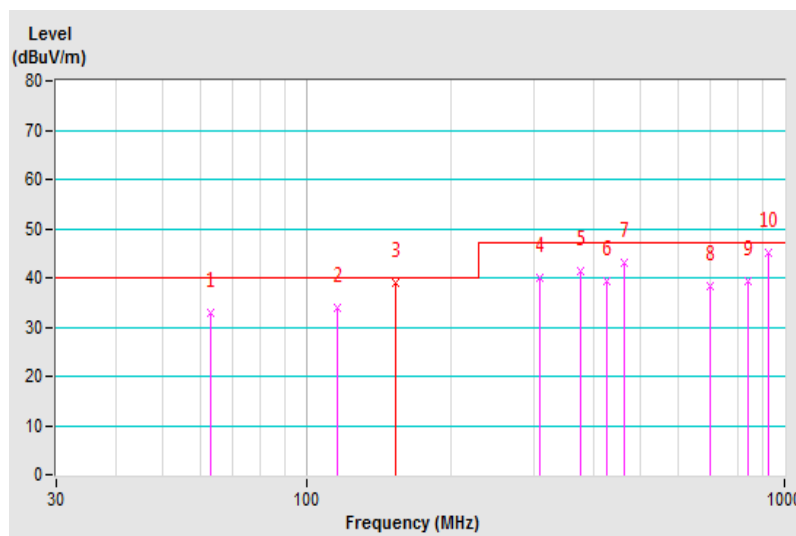

Frequency Range	30MHz ~ 1GHz	Detector Function & Bandwidth	Quasi-Peak (QP), 120kHz
Tested by	ED. Lin	Environmental Conditions	23°C, 70%RH
Test Mode	Mode 1		

Antenna Polarity & Test Distance : Vertical at 10 m								
No	Frequency (MHz)	Emission Level (dBuV/m)	Limit (dBuV/m)	Margin (dB)	Antenna Height (m)	Table Angle (Degree)	Raw Value (dBuV)	Correction Factor (dB/m)
1	34.93	35.78 QP	40.00	-4.22	1.41 V	21	45.65	-9.87
2	75.24	35.98 QP	40.00	-4.02	1.62 V	118	48.15	-12.17
3	102.35	36.33 QP	40.00	-3.67	1.00 V	299	49.43	-13.10
4	116.50	34.27 QP	40.00	-5.73	1.00 V	53	45.66	-11.39
5	125.01	34.09 QP	40.00	-5.91	1.00 V	137	44.66	-10.57
6	154.00	39.00 QP	40.00	-1.00	1.00 V	349	47.80	-8.80
7	200.00	31.21 QP	40.00	-8.79	1.00 V	60	43.37	-12.16
8	462.25	40.21 QP	47.00	-6.79	3.18 V	8	44.53	-4.32
9	742.75	41.95 QP	47.00	-5.05	1.55 V	105	40.77	1.18
10	891.00	41.43 QP	47.00	-5.57	2.35 V	172	38.48	2.95

Remarks:

1. Emission Level(dBuV/m) = Raw Value(dBuV) + Correction Factor(dB/m)
2. Correction Factor(dB/m) = Antenna Factor (dB/m) + Cable Factor (dB) – Pre-Amplifier Factor (dB)
3. The other emission levels were very low against the limit.
4. Margin value = Emission level – Limit value

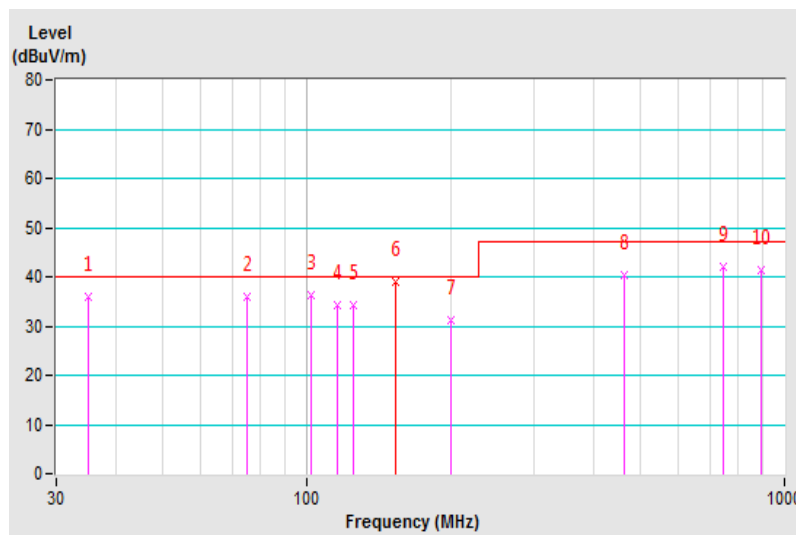

7 Radiated Disturbance above 1 GHz

7.1 Limits

Frequency (GHz)	dBuV/m (at 3m)	
	Average	Peak
1 to 3	56	76
3 to 6	60	80

- Notes: 1. The lower limit shall apply at the transition frequencies.
 2. Emission level (dBuV/m) = 20 log Emission level (uV/m).
 3. All emanations from a class A/B digital device or system, including any network of conductors and apparatus connected thereto, shall not exceed the level of field strengths specified above.

Frequency Range (For unintentional radiators)

Highest frequency generated or used in the EUT or on which the EUT operates or tunes (MHz)	Upper frequency of measurement range (MHz)
Below 108	1000
108-500	2000
500-1000	5000
Above 1000	Up to 5 times of the highest frequency or 6 GHz, whichever is less

7.2 Test Instruments

Description & Manufacturer	Model No.	Serial No.	Cal. Date	Cal. Due
Agilent Spectrum	E4446A	MY51100009	Jun. 4, 2018	Jun. 3, 2019
Agilent Test Receiver	N9038A	MY51210137	Jun. 19, 2018	Jun. 18, 2019
Agilent Preamplifier	8449B	3008A01292	Feb. 22, 2018	Feb. 21, 2019
MITEQ Preamplifier	AMF-6F-260400-33-8P	892164	Feb. 21, 2018	Feb. 20, 2019
EMCI Preamplifier	EMC184045B	980235	Feb. 22, 2018	Feb. 21, 2019
Schwarzbeck Horn Antenna	BBHA-9170	212	Dec. 1, 2017	Nov. 30, 2018
EMCO Horn Antenna	3115	6714	Dec. 12, 2017	Dec. 11, 2018
Max Full. Turn Table	MF7802	MF780208216	NA	NA
Software	Radiated_V8.7.08	NA	NA	NA
SUHNER RF cable With 3/4dB PAD	SF102	Cable-CH10-3.6m	Aug. 13, 2018	Aug. 12, 2019
MICRO-TRONICS Notch filter	BRC50703-01	010	May 31, 2018	May 30, 2019
MICRO-TRONICS Band Pass Filter	BRM17690	005	May 31, 2018	May 30, 2019

- Notes:
1. The calibration interval of the above test instruments is 12 months and the calibrations are traceable to NML/ROC and NIST/USA.
 2. The 3dB beamwidth of the horn antenna is minimum 41 degree (or $w = 2.24m$ at 3m distance) for 1~6 GHz.
 3. The test was performed in Chamber No. 10.
 4. The Industry Canada Reference No. IC 7450E-11.
 5. The VCCI Site Registration No. G-10427
 6. Tested Date: Nov. 16, 2018

7.3 Test Arrangement

- The EUT was placed on the top of a rotating table 0.8 meters above the ground at an accredited chamber room. The table was rotated 360 degrees to determine the position of the highest radiation.
- The EUT was set 3 meters away from the interference-receiving antenna, which was mounted on the top of a variable-height antenna tower.
- The height of antenna can be varied from one meter to four meters, the height of adjustment depends on the EUT height and the antenna 3dB beamwidth both, to detect the maximum value of the field strength. Both horizontal and vertical polarizations of the antenna are set to make the measurement.
- For each suspected emission, the EUT was arranged to its worst case and then the antenna was tuned to heights and the rotatable table was turned from 0 degrees to 360 degrees to find the maximum reading.
- The spectrum analyzer system was set to peak and average detect function and specified bandwidth with maximum hold mode when the test frequency is above 1 GHz.

Note: The resolution bandwidth of test receiver/spectrum analyzer is 1MHz and video bandwidth is 3MHz for Peak detection (PK) at frequency above 1GHz. The resolution bandwidth of test receiver/spectrum analyzer is 1 MHz for Average detection (AV) at frequency above 1GHz.

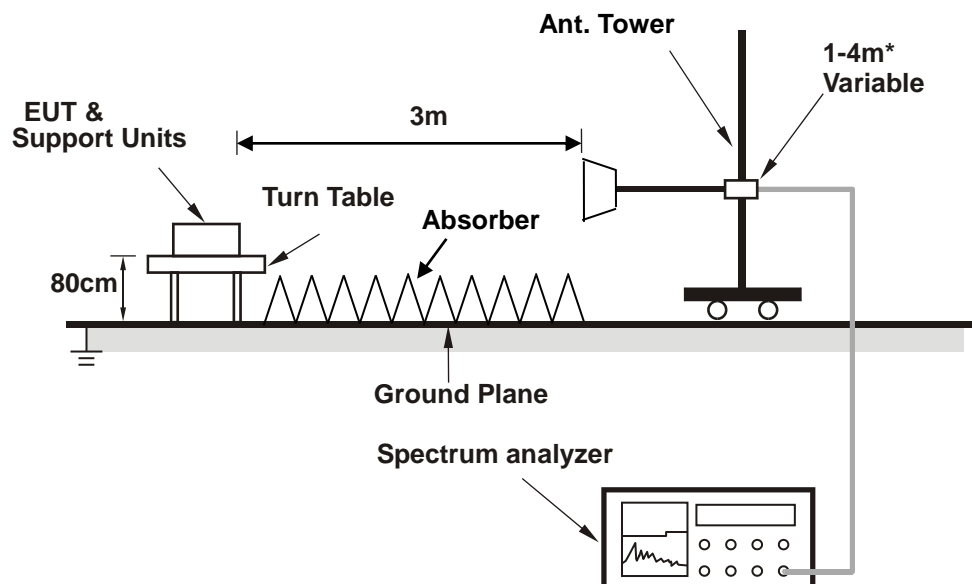

* :depends on the EUT height and the antenna 3dB beamwidth both.

For the actual test configuration, please refer to the related item – Photographs of the Test Configuration.

7.4 Test Results

Frequency Range	1GHz ~ 6GHz	Detector Function & Bandwidth	Peak (PK) / Average (AV), 1MHz
Tested by	Ken Lee	Environmental Conditions	26°C, 71%RH
Test Mode	Mode 1		

Antenna Polarity & Test Distance : Horizontal at 3 m								
No	Frequency (MHz)	Emission Level (dBuV/m)	Limit (dBuV/m)	Margin (dB)	Antenna Height (m)	Table Angle (Degree)	Raw Value (dBuV)	Correction Factor (dB/m)
1	1233.21	55.87 PK	76.00	-20.13	1.76 H	193	59.83	-3.96
2	1233.21	47.27 AV	56.00	-8.73	1.76 H	193	51.23	-3.96
3	2128.71	62.85 PK	76.00	-13.15	2.08 H	34	63.60	-0.75
4	2128.71	44.08 AV	56.00	-11.92	2.08 H	34	44.83	-0.75
5	3853.72	55.76 PK	80.00	-24.24	2.09 H	37	50.31	5.45
6	3853.72	43.09 AV	60.00	-16.91	2.09 H	37	37.64	5.45

Remarks:

1. Emission Level(dBuV/m) = Raw Value(dBuV) + Correction Factor(dB/m)
2. Correction Factor(dB/m) = Antenna Factor (dB/m) + Cable Factor (dB) – Pre-Amplifier Factor (dB)
3. The other emission levels were very low against the limit.
4. Margin value = Emission level – Limit value

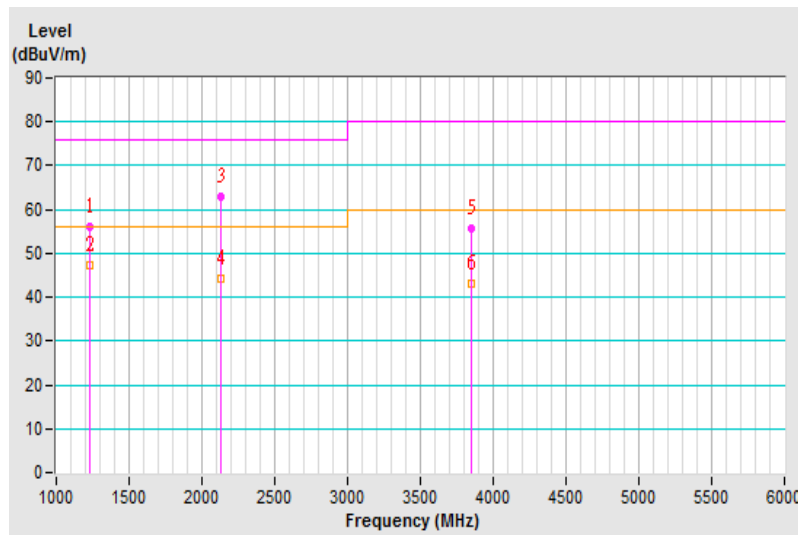

Frequency Range	1GHz ~ 6GHz	Detector Function & Bandwidth	Peak (PK) / Average (AV), 1MHz
Tested by	Ken Lee	Environmental Conditions	26°C, 71%RH
Test Mode	Mode 1		

Antenna Polarity & Test Distance : Vertical at 3 m								
No	Frequency (MHz)	Emission Level (dBuV/m)	Limit (dBuV/m)	Margin (dB)	Antenna Height (m)	Table Angle (Degree)	Raw Value (dBuV)	Correction Factor (dB/m)
1	1079.13	59.46 PK	76.00	-16.54	1.63 V	327	63.18	-3.72
2	1079.13	48.22 AV	56.00	-7.78	1.63 V	327	51.94	-3.72
3	2774.77	59.65 PK	76.00	-16.35	2.11 V	356	59.08	0.57
4	2774.77	50.01 AV	56.00	-5.99	2.11 V	356	49.44	0.57
5	3853.79	62.10 PK	80.00	-17.90	2.13 V	358	56.65	5.45
6	3853.79	48.97 AV	60.00	-11.03	2.13 V	358	43.52	5.45

Remarks:

1. Emission Level(dBuV/m) = Raw Value(dBuV) + Correction Factor(dB/m)
2. Correction Factor(dB/m) = Antenna Factor (dB/m) + Cable Factor (dB) – Pre-Amplifier Factor (dB)
3. The other emission levels were very low against the limit.
4. Margin value = Emission level – Limit value

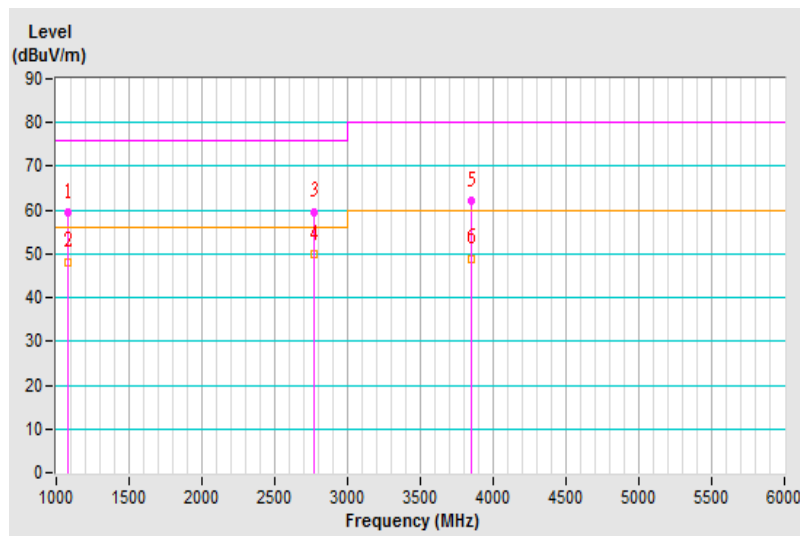

8 Electrostatic Discharge Immunity Test (ESD)

8.1 Test Specification

Basic Standard:	EN 61000-4-2
Discharge Impedance:	330 ohm / 150 pF
Discharge Voltage:	Air Discharge: $\pm 2, \pm 4, \pm 8$ kV (Direct) Contact Discharge: $\pm 2, \pm 4$ kV, ± 6 kV (Direct/Indirect)
Number of Discharge:	Minimum 20 times at each test point
Discharge Mode:	Single Discharge
Discharge Period:	1-second minimum

8.2 Test Instruments

Description & Manufacturer	Model No.	Serial No.	Cal. Date	Cal. Due
KeyTek, ESD Simulator	MZ-15/EC	0504259	Nov. 12, 2018	Nov. 11, 2019

- Notes:
1. The calibration interval of the above test instruments is 12 months and the calibrations are traceable to NML/ROC and NIST/USA.
 2. The test was performed in ESD Room No. 1.
 3. Tested Date: Nov. 23, 2018

8.3 Test Arrangement

- a. Electrostatic discharges were applied only to those points and surfaces of the EUT that are accessible to users during normal operation.
- b. The test was performed with at least ten single discharges on the pre-selected points in the most sensitive polarity.
- c. The time interval between two successive single discharges was at least 1 second.
- d. The ESD generator was held perpendicularly to the surface to which the discharge was applied and the return cable was at least 0.2 meters from the EUT.
- e. Contact discharges were applied to the non-insulating coating, with the pointed tip of the generator penetrating the coating and contacting the conducting substrate.
- f. Air discharges were applied with the round discharge tip of the discharge electrode approaching the EUT as fast as possible (without causing mechanical damage) to touch the EUT. After each discharge, the ESD generator was removed from the EUT and re-triggered for a new single discharge. The test was repeated until all discharges were complete.
- g. At least ten single discharges (in the most sensitive polarity) were applied to the **Horizontal Coupling Plane** at points on each side of the EUT. The ESD generator was positioned at a distance of 0.1 meters from the EUT with the discharge electrode touching the **HCP**.
- h. At least ten single discharges (in the most sensitive polarity) were applied to the center of one vertical edge of the **Vertical Coupling Plane** in sufficiently different positions that the four faces of the EUT were completely illuminated. The **VCP** (dimensions 0.5m x 0.5m) was placed vertically to and 0.1 meters from the EUT.

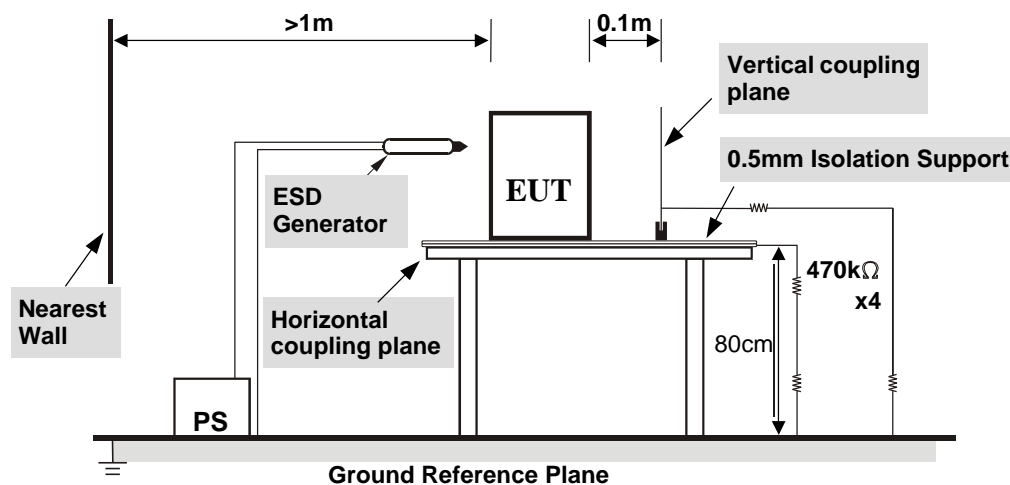

TABLE-TOP EQUIPMENT

The configuration consisted of a wooden table 0.8 meters high standing on the **Ground Reference Plane**. The **GRP** consisted of a sheet of aluminum at least 0.25mm thick, and 2.5 meters square connected to the protective grounding system. A **Horizontal Coupling Plane** (1.6m x 0.8m) was placed on the table and attached to the **GRP** by means of a cable with 940kΩ total impedance. The equipment under test, was installed in a representative system as described in section 7 of EN 61000-4-2, and its cables were placed on the **HCP** and isolated by an insulating support of 0.5mm thickness. A distance of 1-meter minimum was provided between the EUT and the walls of the laboratory and any other metallic structure.

For the actual test configuration, please refer to the related item – Photographs of the Test Configuration.

8.4 Test Results

Input Power	230 Vac, 50 Hz	Tested by	Kent Wang
Environmental Conditions	25 °C, 55% RH 1009 mbar	Test mode	Mode 1

Test Results of Direct Application

Discharge Level (kV)	Polarity (+/-)	Test Point	Contact Discharge	Air Discharge	Performance Criterion
2, 4, 6	+/-	1, 2, 17	Note	NA	A
2, 4, 8	+/-	3 ~ 16	NA	Note	A

Description of test points of direct application: Please refer to following page for representative mark only.

Test Results of Indirect Application

Discharge Level (kV)	Polarity (+/-)	Test Point	Horizontal Coupling Plane	Vertical Coupling Plane	Performance Criterion
2, 4, 6	+/-	Four Sides	Note	Note	A

Description of test points of indirect application:

1. Front side
2. Rear side
3. Right side
4. Left side

Note: The EUT function was correct during the test.

Description of Test Points

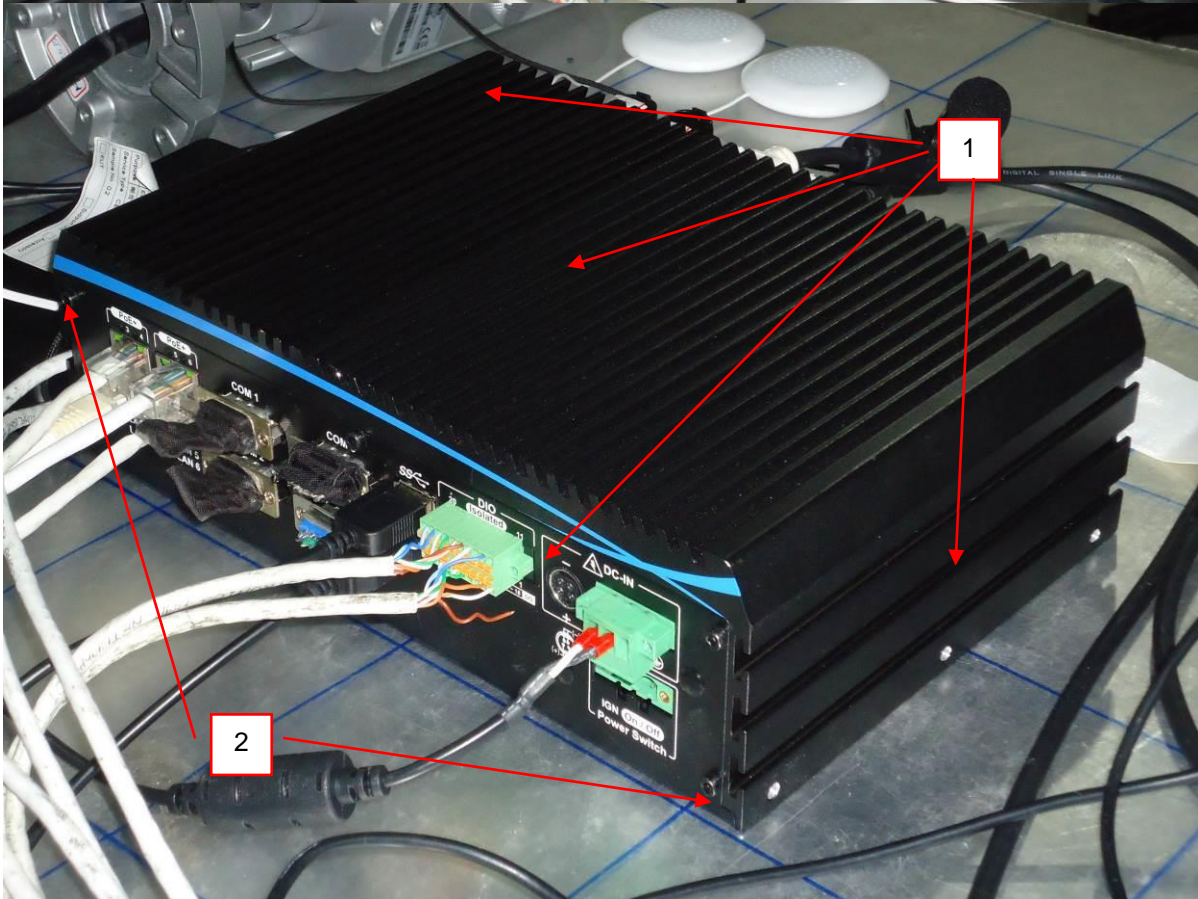
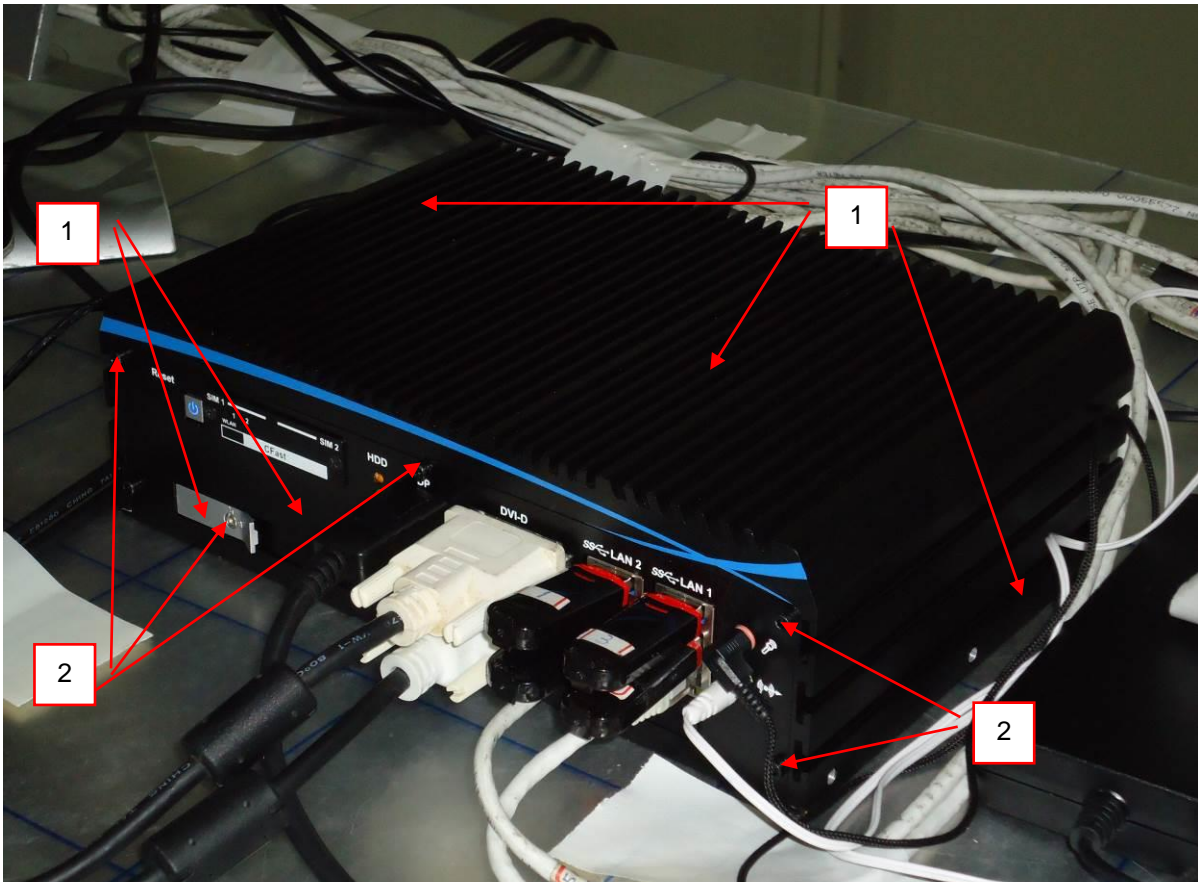

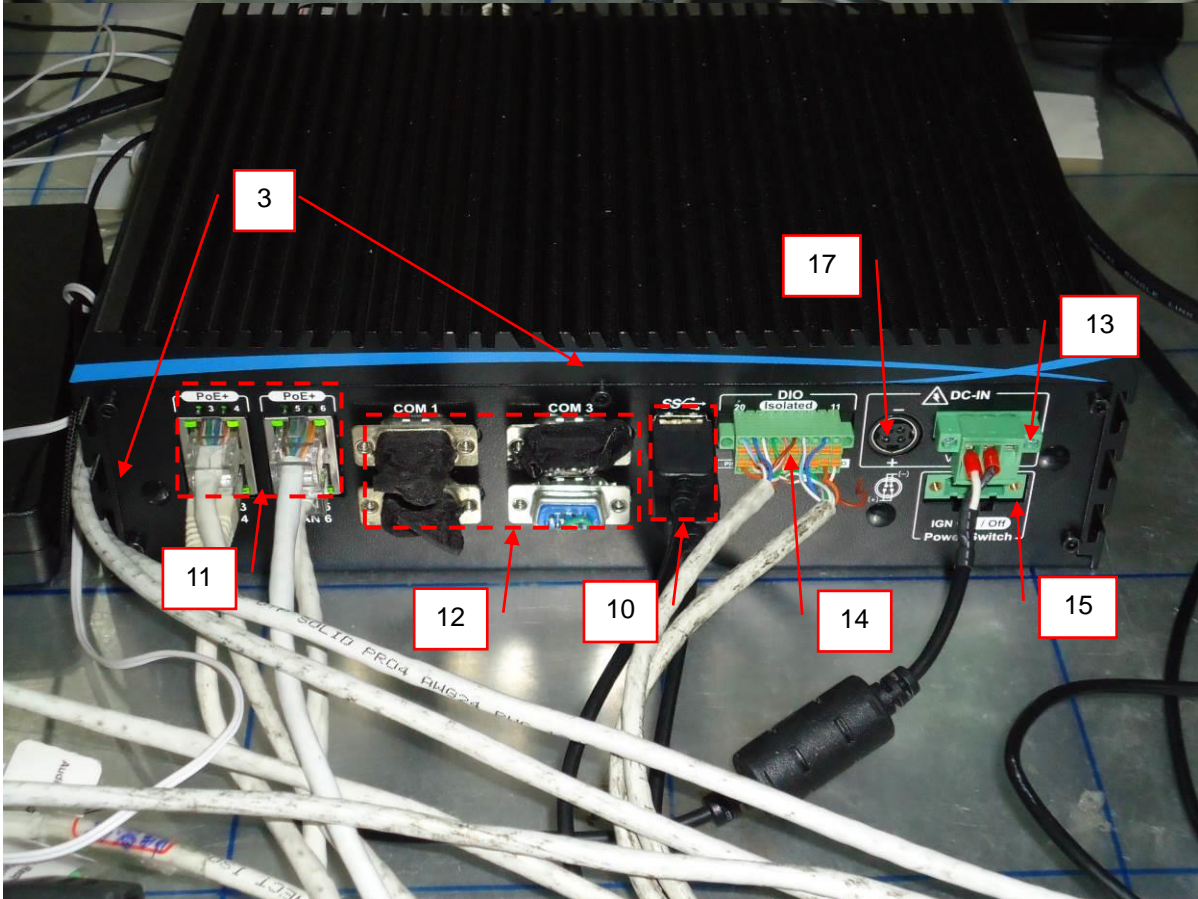
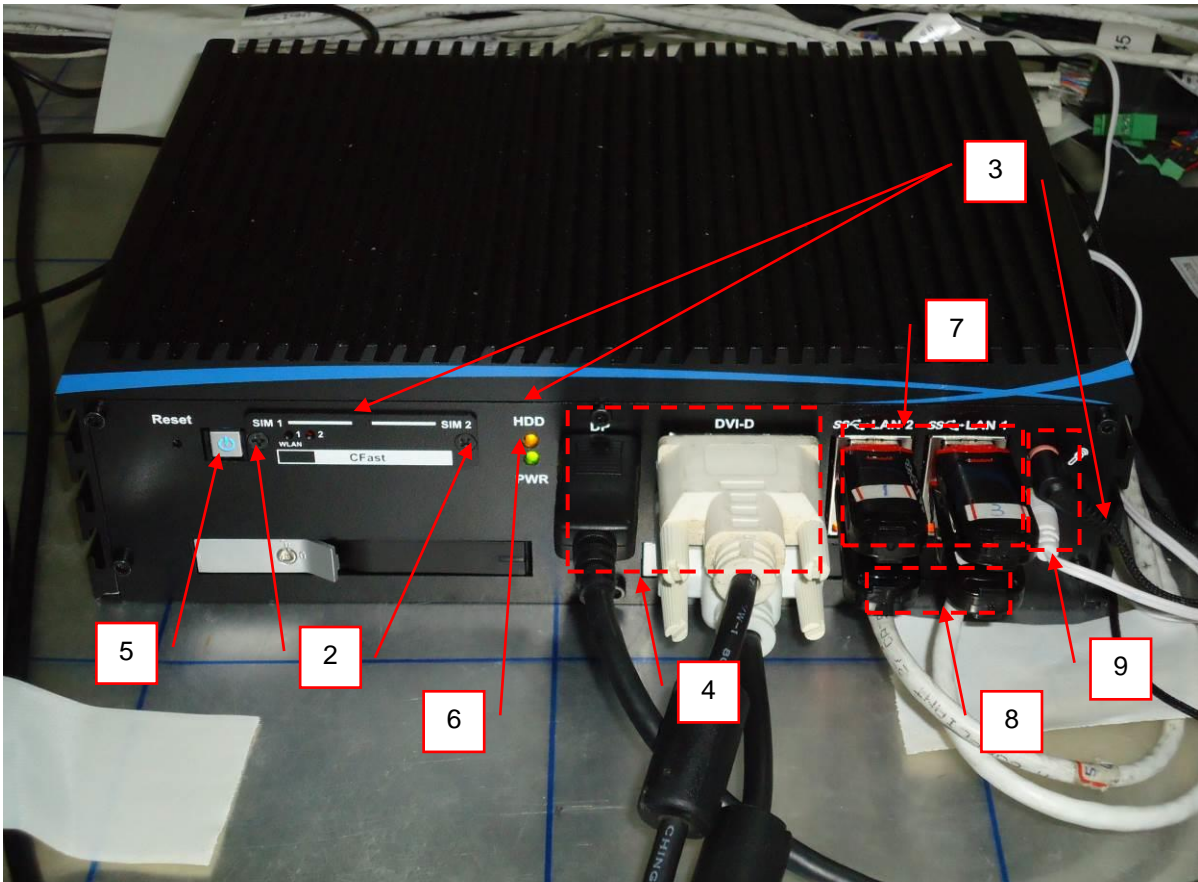

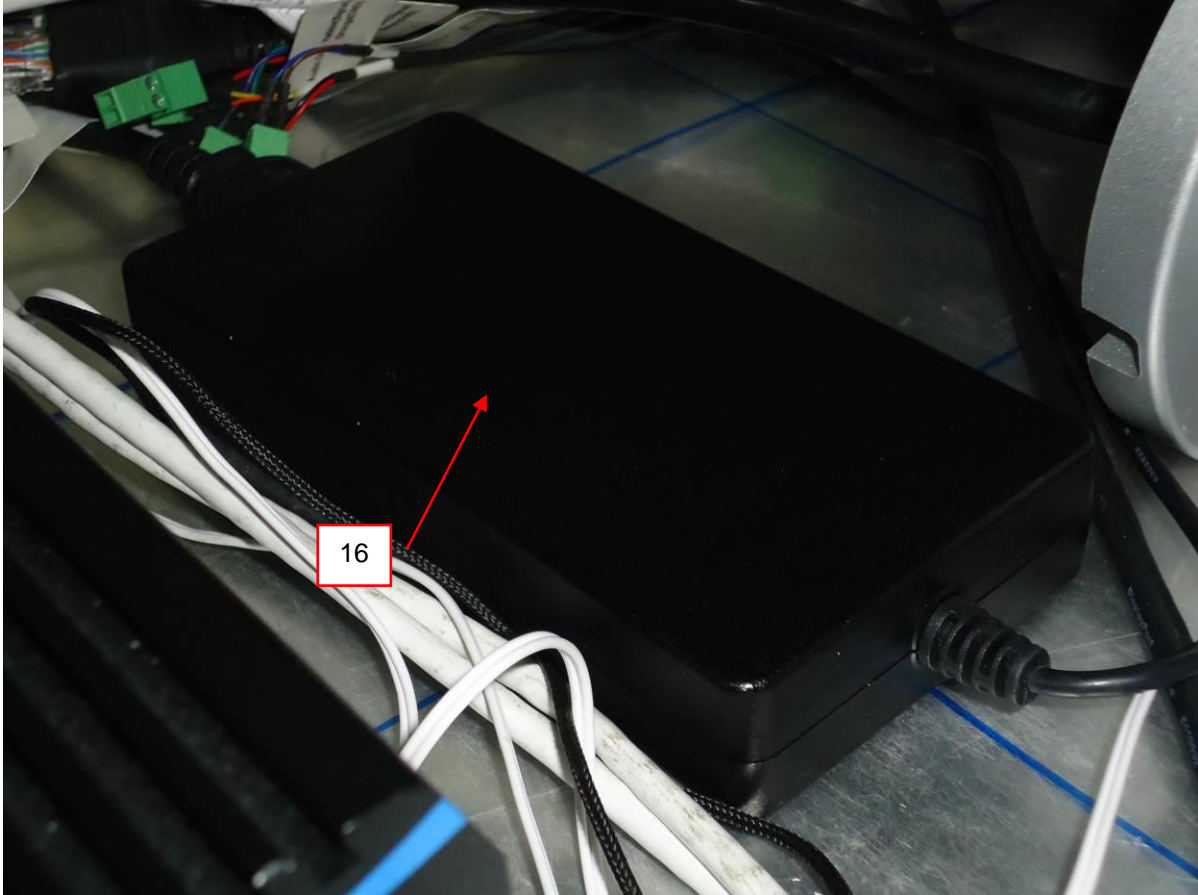
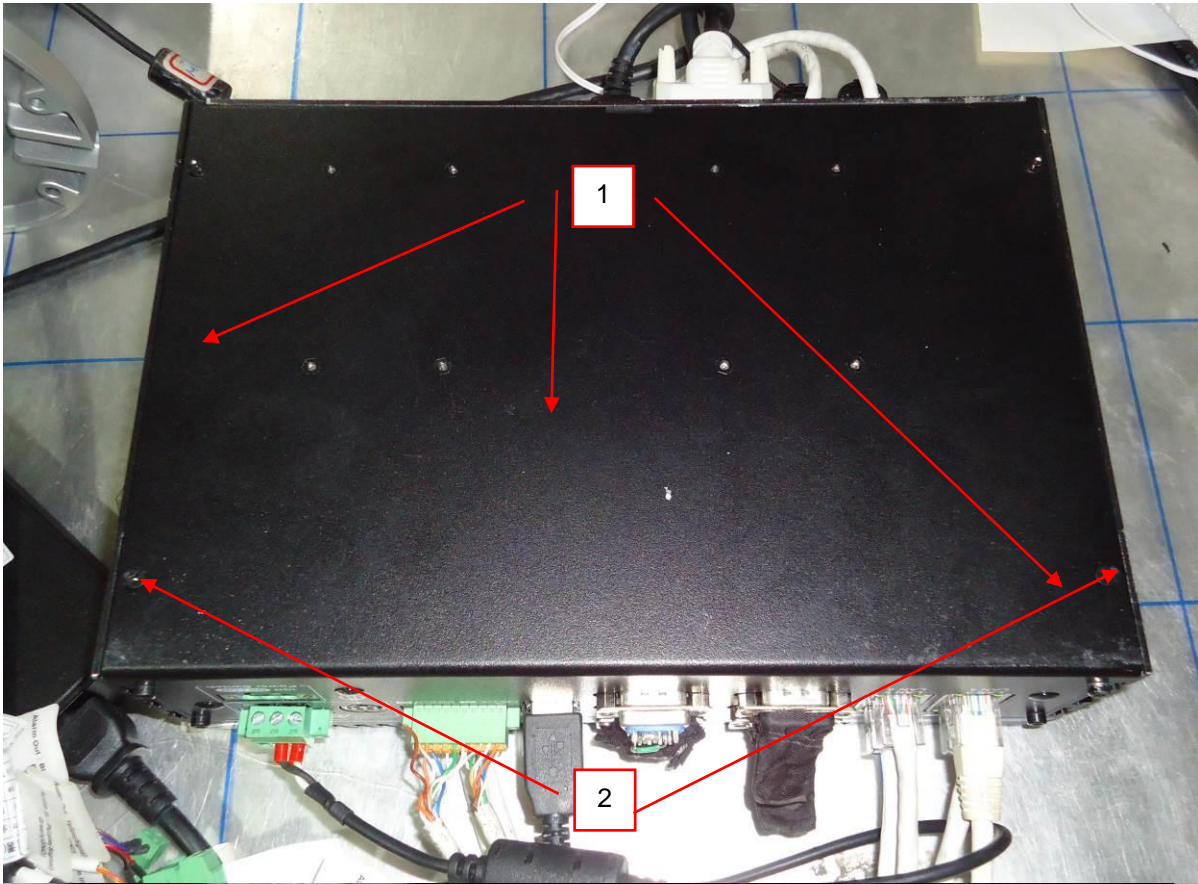

9 Radio-frequency Electromagnetic Field Immunity Test (RS)

9.1 Test Specification

Basic Standard:	EN 61000-4-3
Frequency Range, Field Strength:	80-800 MHz, 20V/m ¹
	800-1000 MHz, 20V/m
	1400-2000 MHz, 10V/m
	2000-2700 MHz, 5V/m
Modulation:	5100-6000 MHz, 3V/m
	1kHz Sine Wave, 80%, AM Modulation
Frequency Step:	1 % of preceding frequency value
Polarity of Antenna:	Horizontal and Vertical
Antenna Height:	1.5m
Dwell Time:	3 seconds

Note 1: This limit applies to equipment mounted in the passenger compartments, drivers cab or external to the rolling stock (roof, underframe). For equipment mounted in all other areas a severity level of 10 V/m may be used.

9.2 Test Instruments

Description & Manufacturer	Model No.	Serial No.	Cal. Date	Cal. Due
Agilent Signal Generator	E8257D	MY48050465	Jun. 6, 2018	Jun. 5, 2019
PRANA RF Amplifier	AP32DP280	0811-894	NA	NA
TESTQ Amplifier	AS1860-50	S-5944/1	NA	NA
AR RF Amplifier	35S4G8AM4	0326094	NA	NA
AR RF Amplifier	100S1G4M3	0329249	NA	NA
AR Controller	SC1000M3	305910	NA	NA
ETS Electric Field Sensor	HI-6105	00217912	Nov. 27, 2017	Nov. 26, 2018
BOONTON RF Voltage Meter	4232A	10180	May 23, 2018	May 22, 2019
BOONTON Power Sensor	51013-4E	34870	Jun. 4, 2018	Jun. 3, 2019
BOONTON Power Sensor	51013-4E	34873	Jun. 4, 2018	Jun. 3, 2019
AR Log-Periodic Antenna	AT6080	0329465	NA	NA
EMCO BiconiLog Antenna	3141	1001	NA	NA
AR High Gain Antenna	AT4010	0329800	NA	NA
Schwarzbeck LOG ANTENNA	Stlp 9149	9149-260	NA	NA
CHANCE MOST Full Anechoic Chamber (9x5x3m)	Chance Most	RS-002	Feb. 6, 2018	Feb. 5, 2019
Software	RS_V7.6	NA	NA	NA

- Notes:
1. The calibration interval of the above test instruments is 12 months and the calibrations are traceable to NML/ROC and NIST/USA.
 2. The test was performed in RS Room No.2.
 3. Tested Date: Nov. 21, 2018

9.3 Test Arrangement

The test procedure was in accordance with EN 61000-4-3.

- a. The testing was performed in a fully anechoic chamber.
- b. The frequency ranges and field strength levels are 80-800 MHz, 20V/m, 800-1000 MHz, 20V/m, 1400-2000 MHz, 10V/m, 2000-2700 MHz, 5V/m and 5100-6000 MHz, 3V/m with the signal 80% amplitude modulated with a 1kHz sine wave.
- c. The test was performed with the EUT exposed to both vertically and horizontally polarized fields on each of the four sides.

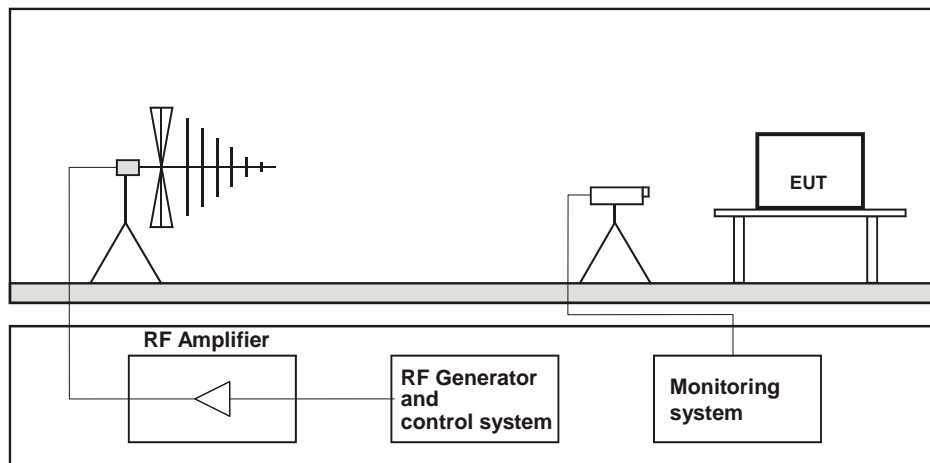

Table-top Equipment

The EUT installed in a representative system as described in section 7 of EN 61000-4-3 was placed on a non-conductive table 0.8 meters in height. The system under test was connected to the power and signal wire according to relevant installation instructions.

For the actual test configuration, please refer to the related item – Photographs of the Test Configuration.

9.4 Test Results

Input Power	230 Vac, 50 Hz	Tested by	Thomas Cheng
Environmental Conditions	23 °C, 61% RH	Test mode	Mode 1

Frequency (MHz)	Polarity	Azimuth(°)	Applied Field Strength		Observation	Test Distance (m)	Performance Criterion
			(V/m)	Modulation			
80 - 800	V&H	0, 90, 180, 270	20	80% AM (1kHz)	Note	1.5	A
800 - 1000	V&H	0, 90, 180, 270	20	80% AM (1kHz)	Note	1.5	A
1400 - 2000	V&H	0, 90, 180, 270	10	80% AM (1kHz)	Note	3	A
2000 - 2700	V&H	0, 90, 180, 270	5	80% AM (1kHz)	Note	3	A
5100 - 6000	V&H	0, 90, 180, 270	3	80% AM (1kHz)	Note	3	A

Note: The EUT function was correct during the test.

10 Electrical Fast Transient/Burst Immunity Test (EFT)

10.1 Test Specification

Basic Standard:	EN 61000-4-4
Test Voltage:	Signal & communication, process measurement & control ports: $\pm 2\text{kV}$, Capacitive clamp Battery referenced ports (except at the output of energy sources), Auxiliary a.c. power input ports (rated voltage $\leq 400\text{ Vrms}$): $\pm 2\text{kV}$
Impulse Repetition Frequency:	5kHz
Impulse Wave Shape:	5/50 (T_r/T_h) ns
Burst Duration:	15 ms
Burst Period:	300 ms
Test Duration:	1 min.

10.2 Test Instruments

Description & Manufacturer	Model No.	Serial No.	Cal. Date	Cal. Due
TESEQ, EFT Simulator	NSG 3060	1572	May 28, 2018	May 27, 2019
Haefely, Capacitive Clamp	IP4A	155173	Apr. 25, 2018	Apr. 24, 2019

- Notes:
1. The calibration interval of the above test instruments is 12 months and the calibrations are traceable to NML/ROC and NIST/USA.
 2. The test was performed in EMS Room No. 2.
 3. Tested Date: Nov. 21, 2018

10.3 Test Arrangement

- Both positive and negative polarity discharges were applied.
- The distance between any coupling devices and the EUT should be 0.5 m for table-top equipment testing, and 1.0 m for floor standing equipment.
- The duration time of each test sequential was 1 minute.
- The transient/burst waveform was in accordance with EN 61000-4-4, 5/50 ns.

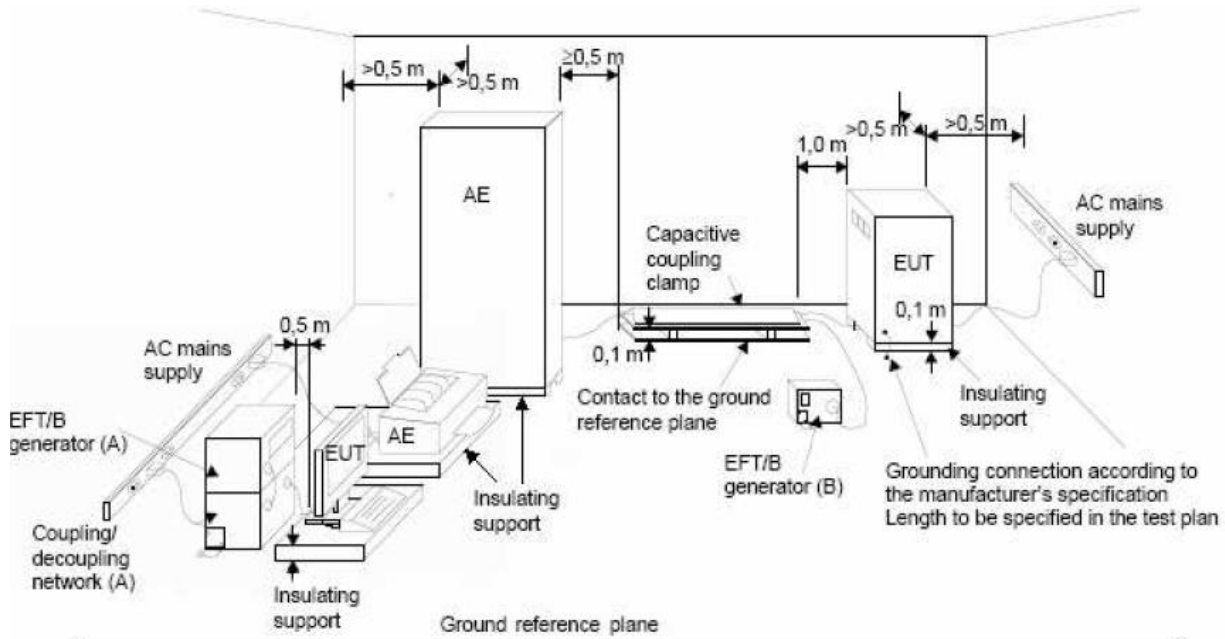

NOTE:

- location for supply line coupling
- location for signal lines coupling

For the actual test configuration, please refer to the related item – Photographs of the Test Configuration.

10.4 Test Results

Input Power	230 Vac, 50 Hz	Tested by	Xun Lee
Environmental Conditions	23°C, 75% RH	Test mode	Mode 1

Auxiliary a.c. power input ports (rated voltage \leq 400 Vrms)

Voltage (kV)	Test Point	Polarity (+/-)	Observation	Performance Criterion
2	L1	+/-	Note	A
2	L2	+/-	Note	A
2	PE	+/-	Note	A
2	L1-L2-PE	+/-	Note	A

Signal & communication, process measurement & control ports

Voltage (kV)	Test Point	Polarity (+/-)	Observation	Performance Criterion
2	RJ 45 (LAN 1)	+/-	Note	A
2	RJ 45 (LAN 2)	+/-	Note	A
2	RJ 45 (PoE LAN 3)	+/-	Note	A

Note: The EUT function was correct during the test.

11 Surge Immunity Test

11.1 Test Specification

Basic Standard:	EN 61000-4-5
Wave-Shape:	Battery referenced ports (except at the output of energy sources), Auxiliary a.c. power input ports (rated voltage ≤ 400 Vrms): 1.2/50 μ s Open Circuit Voltage 8/20 μ s Short Circuit Current
Test Voltage:	Line to line: ± 0.5 kV, ± 1 kV, Line to ground: ± 0.5 kV, ± 1 kV, ± 2 kV output impedance of 42 Ω (40 Ω and 2 Ω generator) and a coupling capacitance of 0,5 μ F
AC Phase Angle (degree):	0°, 90°, 180°, 270°
Pulse Repetition Rate:	1 time / 20 sec.
Number of Tests:	5 positive and 5 negative at selected points

11.2 Test Instruments

Description & Manufacturer	Model No.	Serial No.	Cal. Date	Cal. Due
TESEQ, Surge Simulator	NSG 3060	1572	May 28, 2018	May 27, 2019
Coupling Decoupling Network	CDN-UTP8	045	Aug. 27, 2018	Aug. 26, 2019
TESEQ Coupling Decoupling Network	CDN HSS-2	41009	May 23, 2018	May 22, 2019
TESEQ Coupling Decoupling Network	CDN 118-T8	40386	Sep. 20, 2018	Sep. 19, 2019
TESEQ CDN for Unshielded Unsymmetrical Signal & Data Lines	CDN117	40144	Sep. 20, 2018	Sep. 19, 2019

- Notes:
1. The calibration interval of the above test instruments is 12 months and the calibrations are traceable to NML/ROC and NIST/USA.
 2. The test was performed in EMS Room No. 2.
 3. Tested Date: Nov. 21, 2018

11.3 Test Arrangement

The surge is to be applied to the EUT power supply terminals via the capacitive coupling network. Decoupling networks are required in order to avoid possible adverse effects on equipment not under test that may be powered by the same lines, and to provide sufficient decoupling impedance to the surge wave. The power cord between the EUT and the coupling/decoupling networks shall be 2 meters in length (or shorter).

For double-insulated products without PE or external earth connections, the test shall be done in a similar way as for grounded products but without adding any additional external grounded connections. If there are no other possible connections to earth, line-to-ground tests may be omitted.

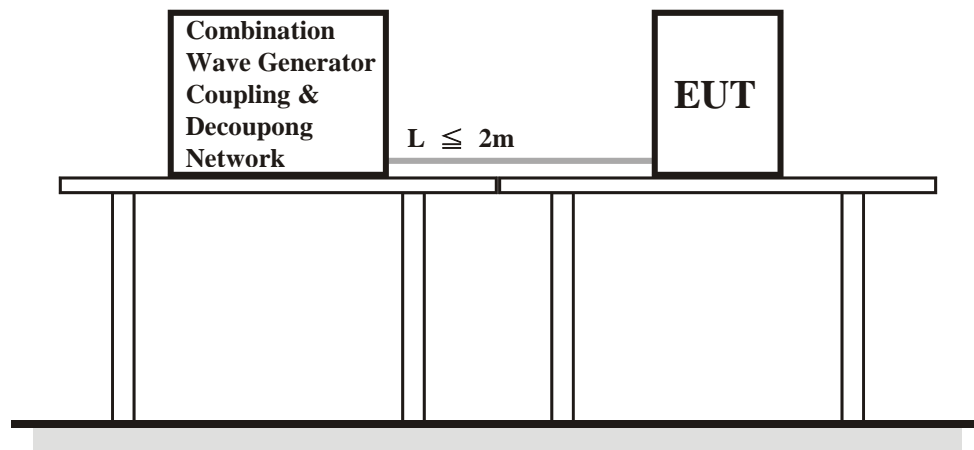

For the actual test configuration, please refer to the related item – Photographs of the Test Configuration.

11.4 Test Results

Input Power	230 Vac, 50 Hz	Tested by	Xun Lee
Environmental Conditions	23 °C, 75% RH	Test mode	Mode 1

Auxiliary a.c. power input ports (rated voltage ≤ 400 Vrms)

Voltage (kV)	Test Point	Polarity (+/-)	Observation	Performance Criterion
0.5, 1 (42 Ω + 0,5 μ F)	L1-L2	+/-	Note	A
0.5, 1, 2 (42 Ω + 0,5 μ F)	L1-PE	+/-	Note	A
0.5, 1, 2 (42 Ω + 0,5 μ F)	L2-PE	+/-	Note	A

Note: The EUT function was correct during the test.

12 Immunity to Conducted Disturbances Induced by RF Fields (CS)

12.1 Test Specification

Basic Standard:	EN 61000-4-6
Frequency Range:	0.15 MHz - 80 MHz
Voltage Level:	Battery referenced ports (except at the output of energy sources), Auxiliary a.c. power input ports (rated voltage \leq 400 Vrms), Signal & communication, process measurement & control ports: 10 V
Modulation:	1kHz Sine Wave, 80%, AM Modulation
Frequency Step:	1 % of preceding frequency value
Dwell Time	3 seconds

12.2 Test Instruments

Description & Manufacturer	Model No.	Serial No.	Cal. Date	Cal. Due
ROHDE & SCHWARZ Signal Generator	SML03	101801	Jan. 8, 2018	Jan. 7, 2019
Digital Sweep Function Generator	8120	984801	NA	NA
AR Power Amplifier	75A250AM1	306331	NA	NA
FCC Coupling Decoupling Network	FCC-801-M2-16A	01047	Jun. 20, 2018	Jun. 19, 2019
FISCHER CUSTOM COMMUNICATIONS EM Injection Clamp	F-203I-23mm	455	NA	NA
FISCHER CUSTOM COMMUNICATIONS Current Injection Clamp	F-120-9A	361	Jul. 24, 2018	Jul. 23, 2019
B&K Ear Simulator	4185	2553594	NA	NA
EM TEST Coupling Decoupling Network	CDN M1/32A	306508	Jun. 20, 2018	Jun. 19, 2019
TESEQ Coupling Decoupling Network	CDN T800	34428	Jun. 20, 2018	Jun. 19, 2019
FCC Coupling Decoupling Network	FCC-801-T4	02031	Jun. 20, 2018	Jun. 19, 2019
EM TEST Coupling Decoupling Network	CDN T2	306509	Jun. 20, 2018	Jun. 19, 2019
R&S Power Sensor	NRV-Z5	837878/039	Nov. 10, 2018	Nov. 9, 2019
R&S Power Meter	NRVD	837794/040	Nov. 10, 2018	Nov. 9, 2019
TESEQ Coupling Decoupling Network	CDN M232	37702	Jun. 20, 2018	Jun. 19, 2019
TESEQ Coupling Decoupling Network	CDN M332	41258	Jun. 20, 2018	Jun. 19, 2019
TESEQ Coupling Decoupling Network	CDN M332	41256	Jun. 20, 2018	Jun. 19, 2019
TESEQ Coupling Decoupling Network	CDN T400A	28569	Jun. 20, 2018	Jun. 19, 2019
TESEQ Coupling Decoupling Network	CDN T8-10	40376	Jun. 20, 2018	Jun. 19, 2019
TESEQ Coupling Decoupling Network	ISN ST08	41212	Jun. 20, 2018	Jun. 19, 2019
FCC Coupling Decoupling Network	FCC-801-M5-50A	100018	Jan. 24, 2018	Jan. 23, 2019
Software	CS_V7.4.2	NA	NA	NA

- Notes:
1. The calibration interval of the above test instruments is 12 months and the calibrations are traceable to NML/ROC and NIST/USA.
 2. The test was performed in CS Room No. 1.
 3. Tested Date: Nov. 22, 2018

12.3 Test Arrangement

- The EUT shall be tested within its intended operating and climatic conditions.
- An artificial hand was placed on the hand-held accessory and connected to the ground reference plane.
- One of the CDNs not used for injection was terminated with 50 ohm, providing only one return path. All other CDNs were coupled as decoupling networks.
- The frequency range is swept from 150 kHz to 80 MHz, using the signal level established during the setting process and with a disturbance signal of 80 % amplitude. The signal is modulated with a 1 kHz sine wave, pausing to adjust the RF signal level or the switch coupling devices as necessary. Where the frequency is swept incrementally, the step size shall not exceed 1 % of the preceding frequency value.
- Attempts should be made to fully exercise the EUT during testing, and to fully interrogate all exercise modes selected for susceptibility.

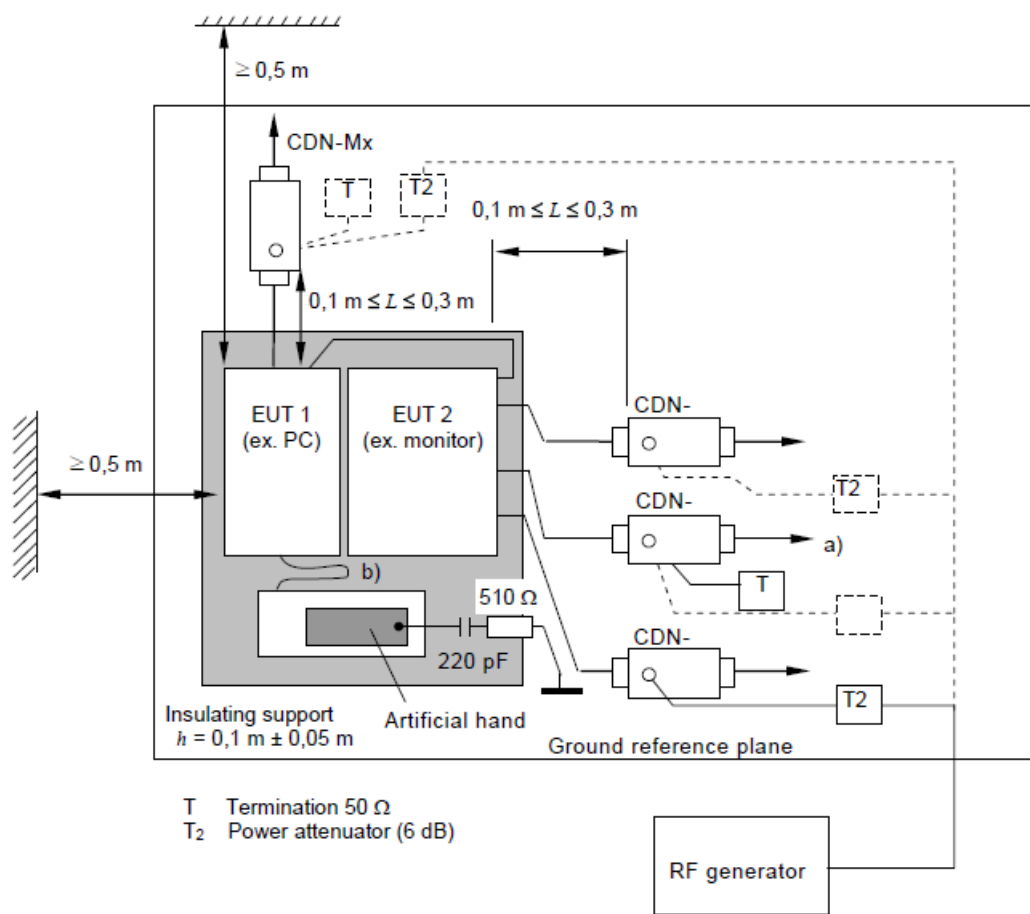

- Note:**
- The EUT clearance from any metallic obstacles shall be at least 0,5 m.
 - Interconnecting cables (≤ 1 m) belonging to the EUT shall remain on the insulating support.
 - The equipment to be tested is placed on an insulating support of 0.1 meters height above a ground reference plane. All relevant cables shall be provided with the appropriate coupling and decoupling devices at a distance between 0.1 meters and 0.3 meters from the projected geometry of the EUT on the ground reference plane.

For the actual test configuration, please refer to the related item – Photographs of the Test Configuration.

12.4 Test Results

Input Power	230 Vac, 50 Hz	Tested by	Thomas Cheng
Environmental Conditions	20 °C, 63% RH	Test mode	Mode 1

Frequency (MHz)	Level (V rms)	Tested Line	Injection Method	Return Path	Observation	Remark	Performance Criterion
0.15 – 80	10	AC Power	CDN-M3	CDN-M1	Note	-	A
0.15 – 80	10	STP LAN 1	ISN ST-08	CDN-M1	Note	-	A
0.15 – 80	10	STP LAN 2	ISN ST-08	CDN-M1	Note	-	A
0.15 – 80	10	RJ45 (PoE LAN 3)	CDN-T8	CDN-M1	Note	-	A

Note: The EUT function was correct during the test.

13 Pictures of Test Arrangements

13.1 Conducted Disturbance at Auxiliary a.c. or d.c. power ports



13.2 Radiated Disturbance up to 1 GHz

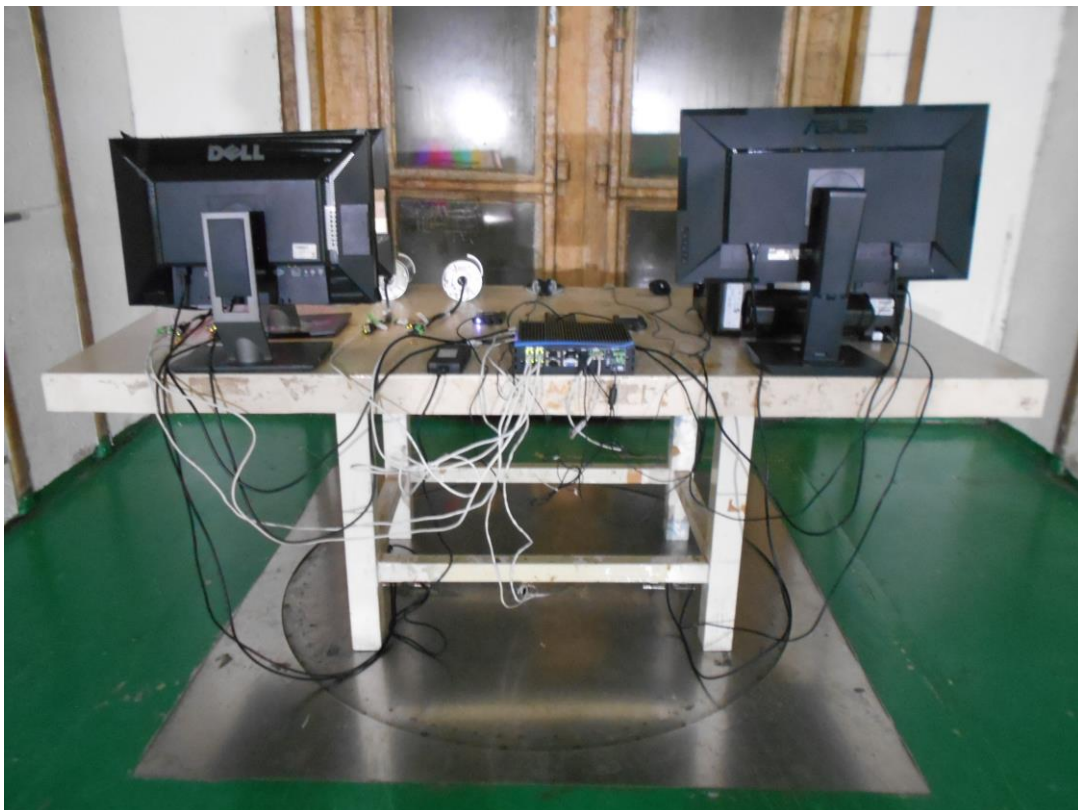

13.3 Radiated Disturbance above 1 GHz

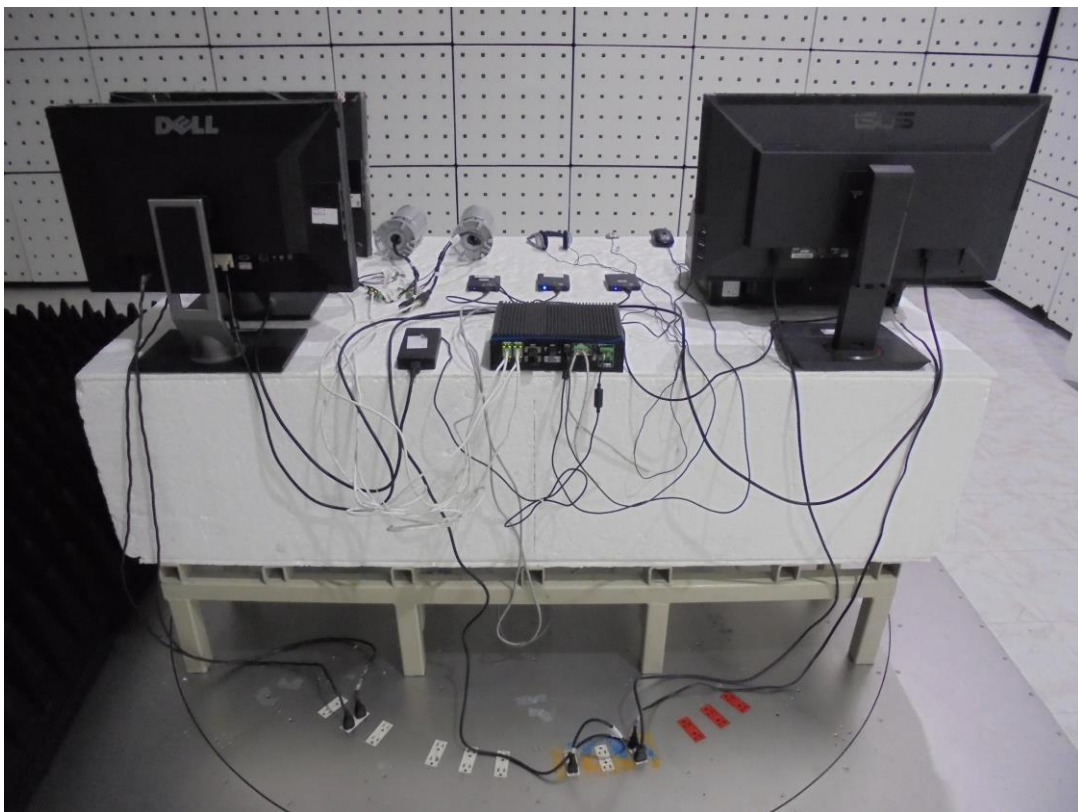

13.4 Electrostatic Discharge Immunity Test (ESD)



13.5 Radio-frequency Electromagnetic Field Immunity Test (RS)

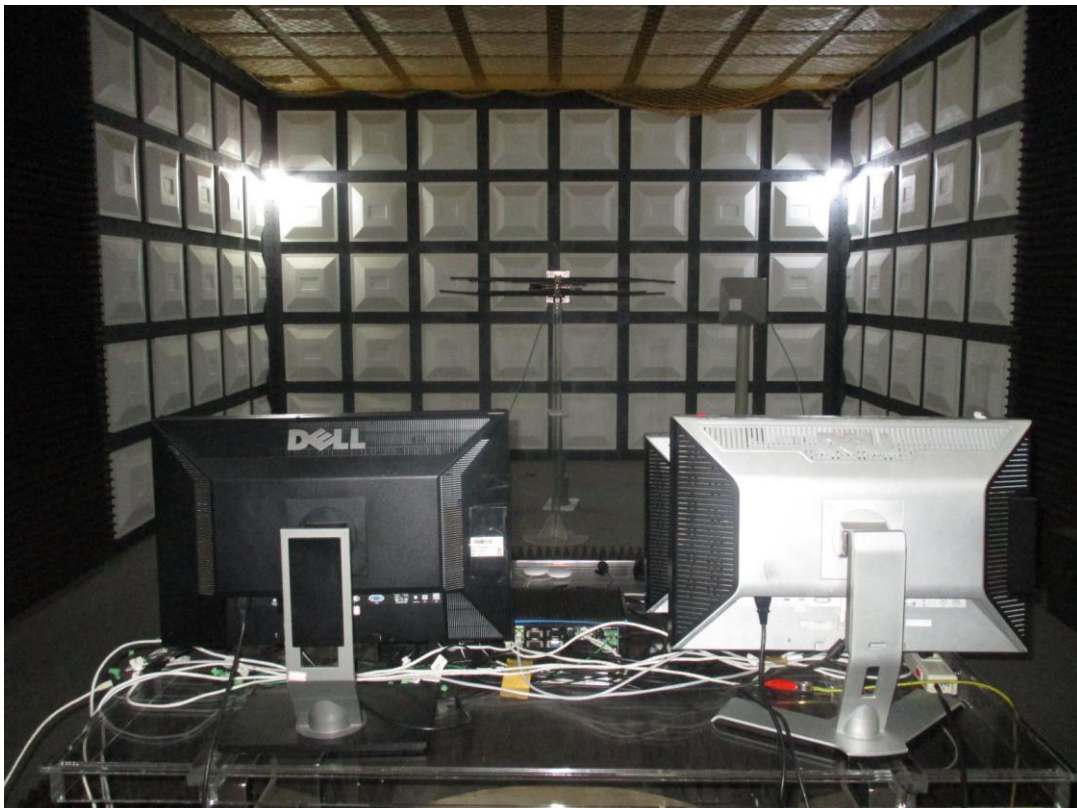

13.6 Fast Transients (EFT)

Mains ports



LAN



13.7 Surge

Mains ports



13.8 Radio-frequency common mode (CS)

Mains ports



STP LAN



PoE LAN



Appendix – Information on the Testing Laboratories

We, Bureau Veritas Consumer Products Services (H.K.) Ltd., Taoyuan Branch, were founded in 1988 to provide our best service in EMC, Radio, Telecom and Safety consultation. Our laboratories are accredited and approved according to ISO/IEC 17025.

If you have any comments, please feel free to contact us at the following:

Linko EMC/RF Lab

Tel: 886-2-26052180

Fax: 886-2-26051924

Hsin Chu EMC/RF/Telecom Lab

Tel: 886-3-6668565

Fax: 886-3-6668323

Hwa Ya EMC/RF/Safety Lab

Tel: 886-3-3183232

Fax: 886-3-3270892

Email: service.adt@tw.bureauveritas.com

Web Site: www.bureauveritas-adt.com

The address and road map of all our labs can be found in our web site also.

--- END ---